

BLACK FUTON FRAME

ASSEMBLY INSTRUCTIONS

ITEM# BSF1002

SKU# 616108001

Need help? We are here for you!
www.biglots.com/help/contact-us

GENERAL BEST PRACTICES FOR ASSEMBLY:

Read all instructions before starting

Clear a flat covered space to be used

Two adults are recommended for assembly

Note that hardware required is provided for every step

Pay attention to orientation

Letter of the part corresponds to a sticker on the product

Number of the hardware corresponds to its number in the package

Helpful hints provided along the way

MAINTENANCE:

Check Bolts/screws periodically and tighten if necessary.

WARNING: Should this product become damaged, and/or components are broken or missing, DO NOT USE.

CARE AND CLEANING:

DO NOT scratch or chip the finish.

DO NOT use abrasive chemicals for cleaning.

Clean with mild soap on a soft rag.

Rinse and dry thoroughly.

WARNINGS:

Caution: Adult assembly required. Assembly will require at least 2 people.
Assemble on soft surfaces to prevent damage to the product finish.

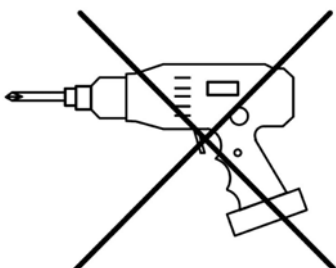

DO NOT USE POWER TOOLS TO ASSEMBLE

PARTS LIST

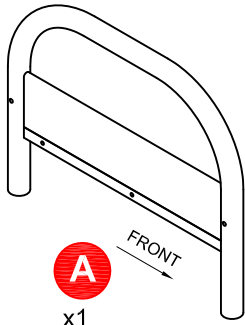

A
x1
Left Arm

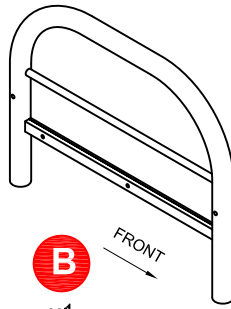

B
x1
Right Arm

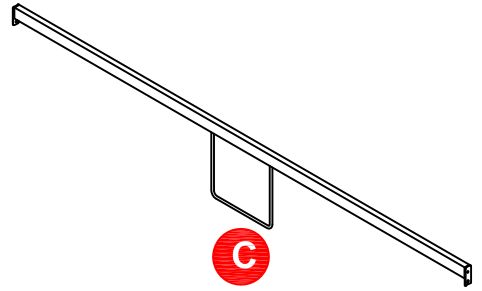

C
x1
Front brace

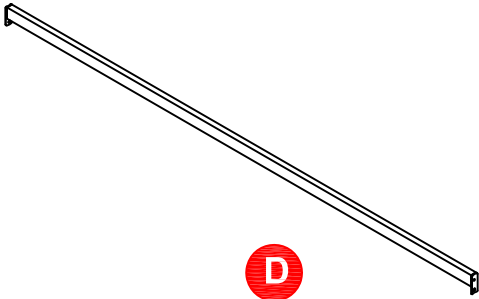

D
x1
Back Brace

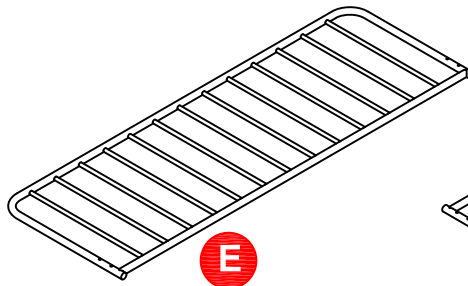

E
x1
Back Frame

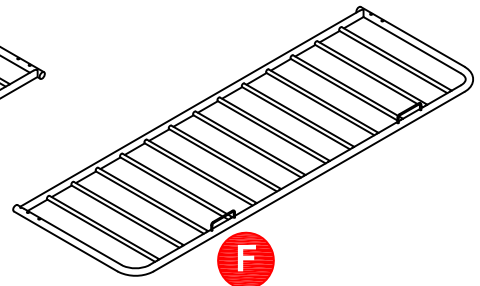

F
x1
Front frame

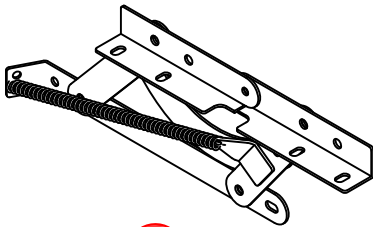

G
x1
Right Mechanism

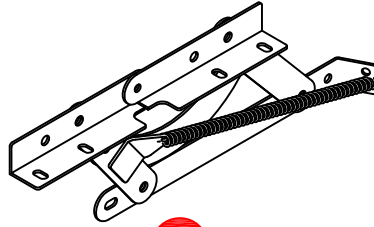

H
x1
Left Mechanism

HARDWARE LIST



1

x4
ALLEN BOLT
5/16"x2³/₄"

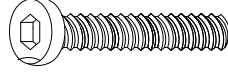

2

x8
ALLEN BOLT
5/16"x1³/₄"

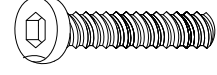

3

x4
ALLEN BOLT
5/16"x1¹/₄"

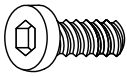

4

x4
ALLEN BOLT
1/4"x⁵/₈"



5

x4
FLAT WASHER
Ø30mm



6

x4
FLAT WASHER
Ø24mm



7

x20
FLAT WASHER
Ø18mm



8

x4
LOCK WASHER
Ø13mm



9

x12
NUT
5/16"



10

x2
HOOK
130mm



11

x1
ALLEN WRENCH
5x5x60mm

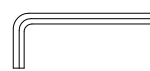

12

x1
ALLEN WRENCH
4x4x60mm



13

x1
Open Wrench
13mm

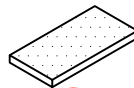

14

x4
PAD
20x40mm

STEP 1

With assistance from another adult, attach Front Brace (C) and Back Brace (D) to Left Arm (A) and Right Arm (B) with Bolts (1), Flat Washer (5) and Lock Washer (8) using Allen Wrench (11). Secure the bottoms of the braces to the arms with Bolts (4) using Allen Wrench (12). Do Not fully tighten bolts at this time.

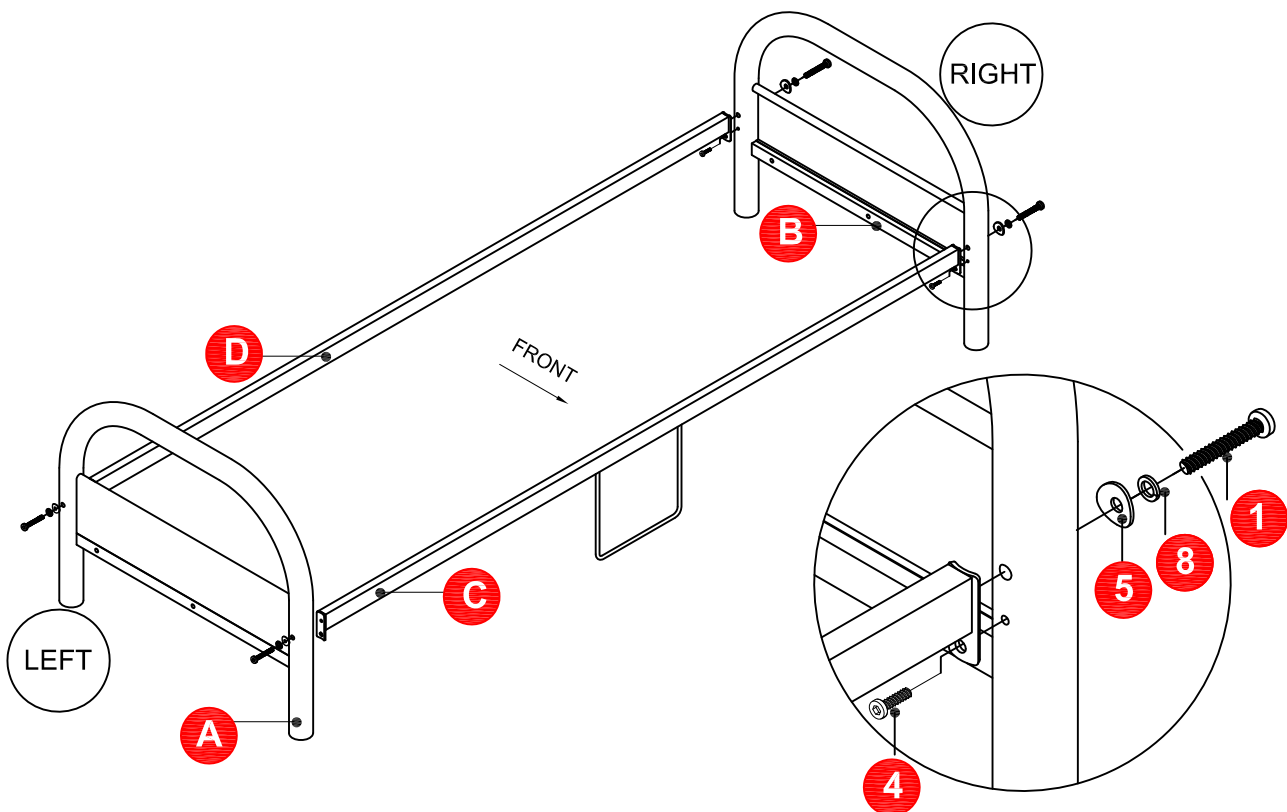
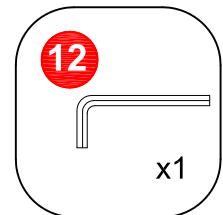
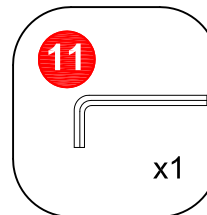
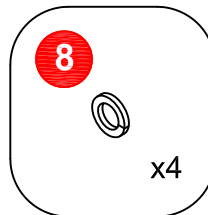
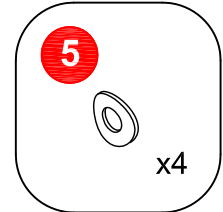
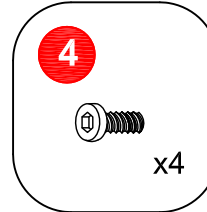
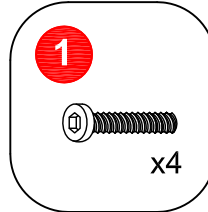

Assembled view:

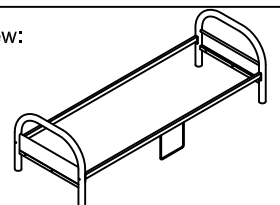

STEP 2

Attach Left Mechanism (H) to the inside of Left Arm (A) using Bolts (3), Flat Washer (6), Flat Washer (7) and Nut (9) using Allen Wrench (11) and Open Wrench (13) as shown in the diagram. Repeat process to Attach Right Mechanism (G) to Right Arm (B).

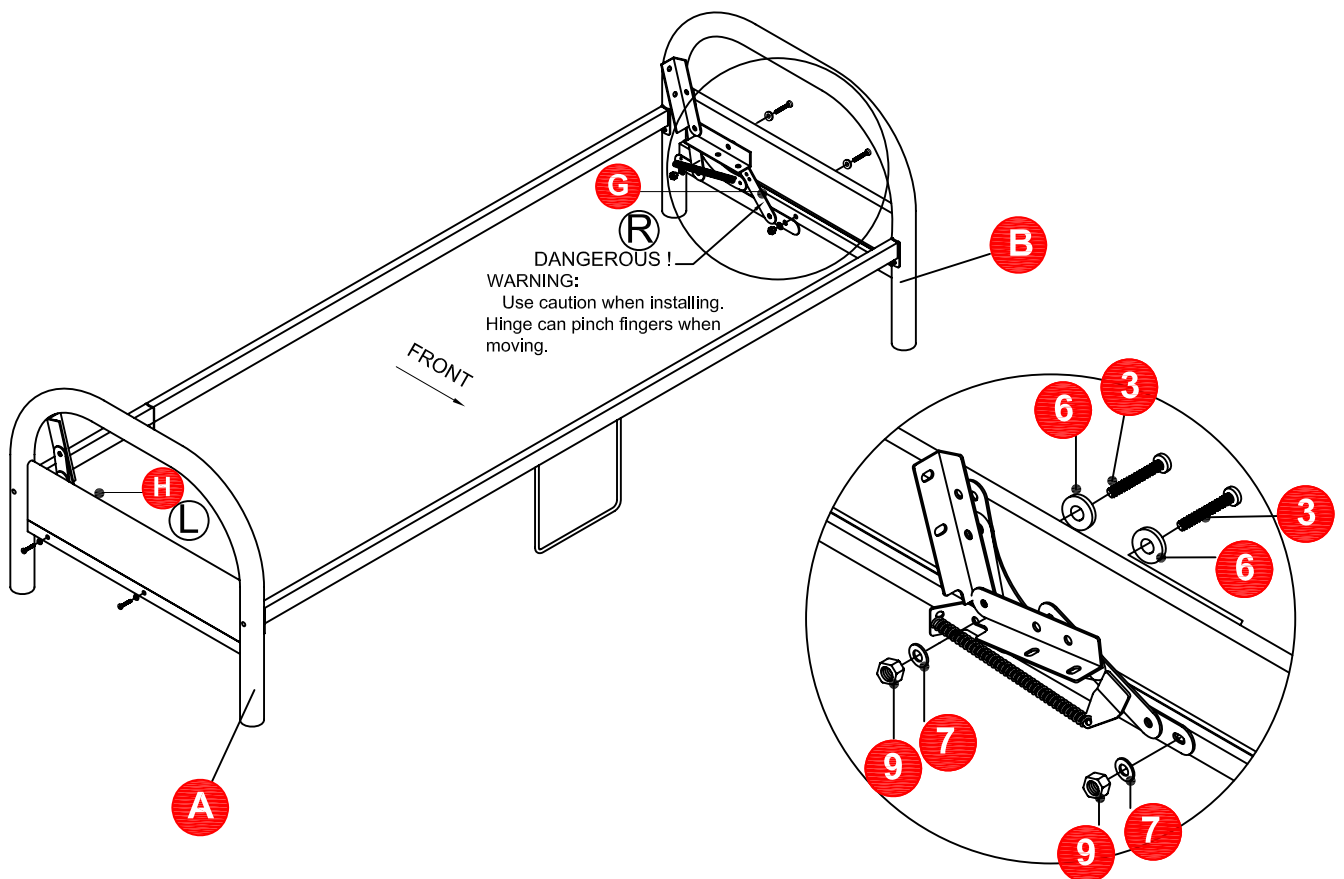
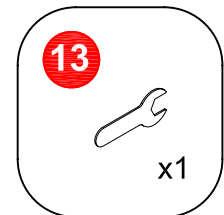
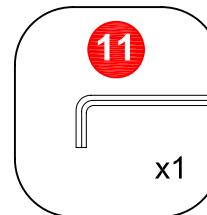
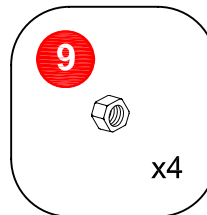
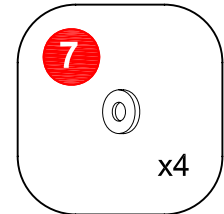
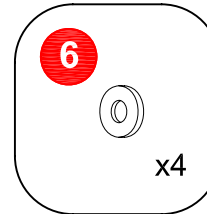
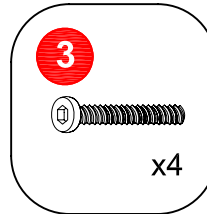

Assembled view:

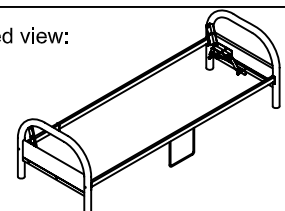

STEP 3

Align the holes of Front Frame (F) with the holes in the Left Mechanism (H) and Right Mechanism (G). Note: The cushion stops on Front Frame (F) should be facing up. Secure the Front Frame in place using Bolts (2), Flat Washer (7) and Nut (9) using Allen Wrench (11) and Open Wrench (13). With assistance from another adult, repeat the process to attach the Back Frame (E) to the Left Mechanism (H) and Right Mechanism (G).

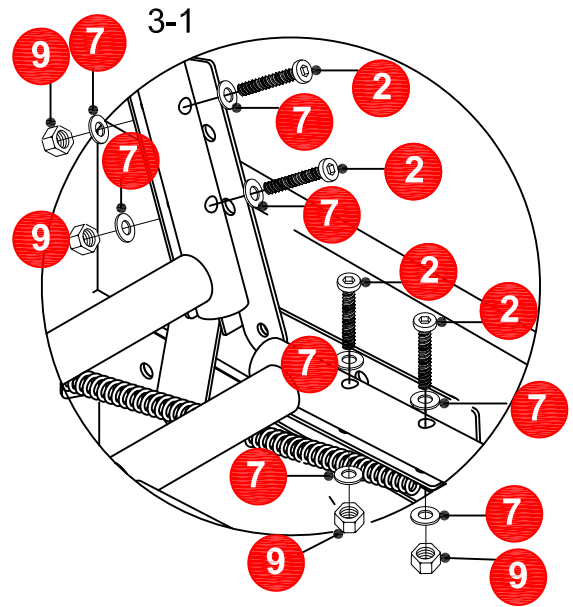
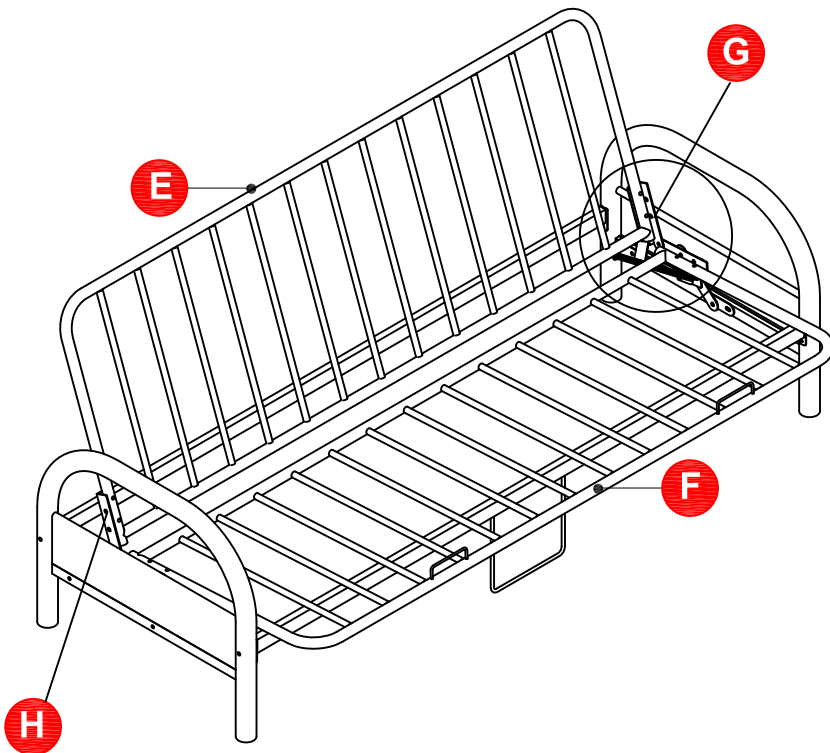
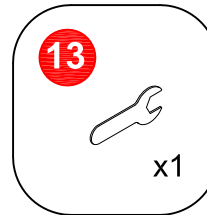
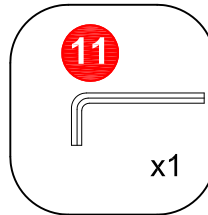
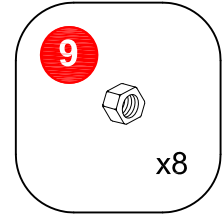
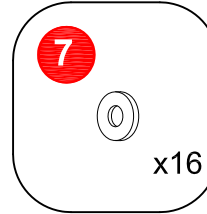
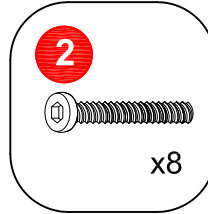

Assembled view:

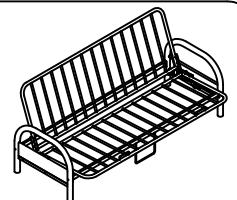

STEP 4

Connect the Front Frame (F) to Back Frame (E) using Hook (10) as shown in the diagram. Carefully place the frame in the flat position as shown in Step 5. Place Pad (14) under the front Frame (F) and Back Frame (E) where the contact Front Brace (C) and Back Brace (D). Ensure the assembled frame is square and fully tighten All bolts from Steps 1 through 3.

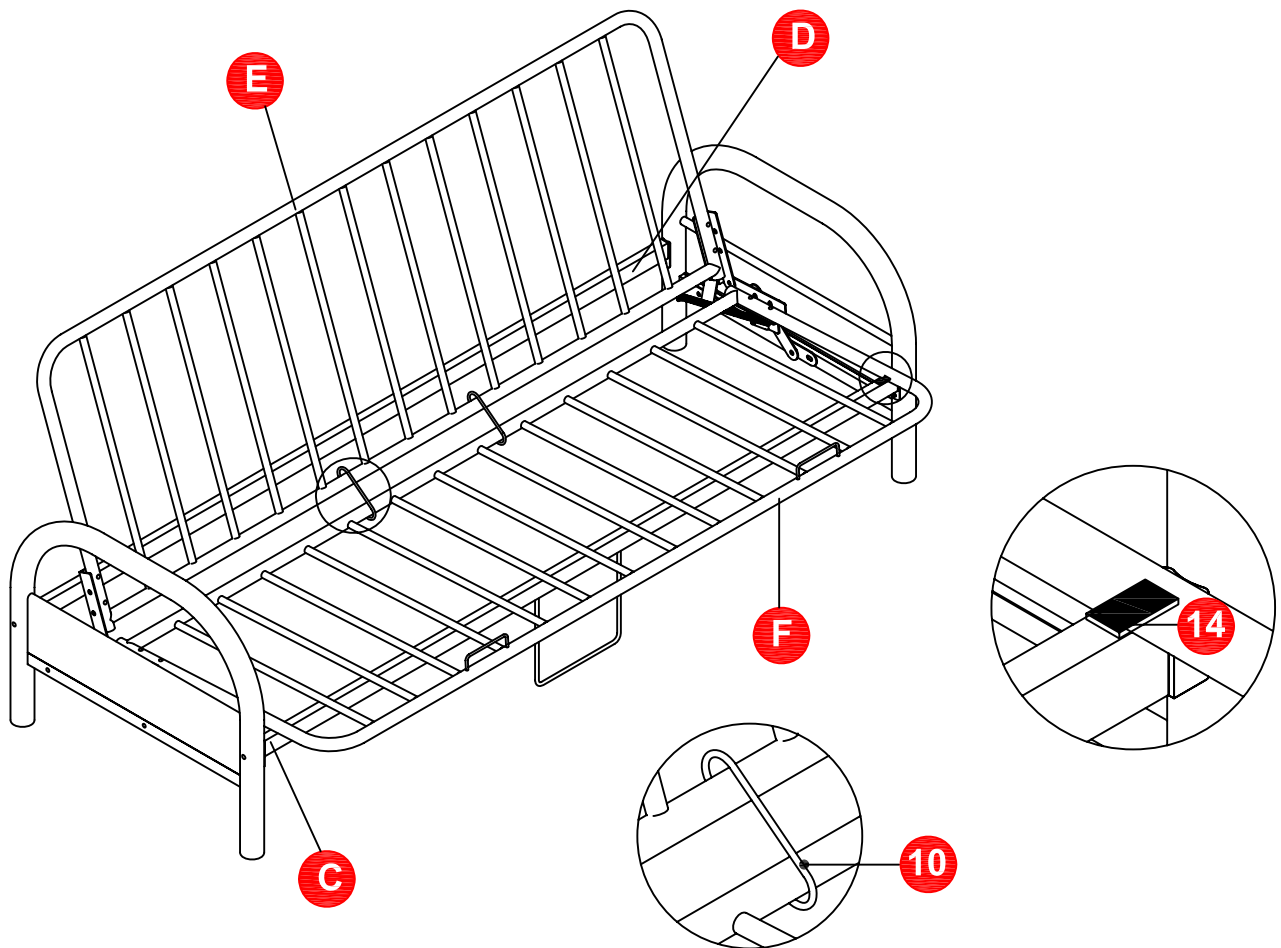
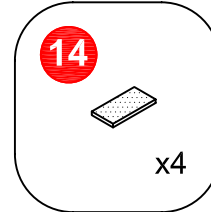
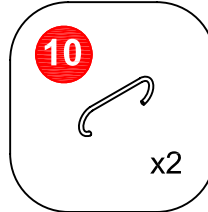

STEP 5

To convert the sofa to a bed, follow the instruction cited below.

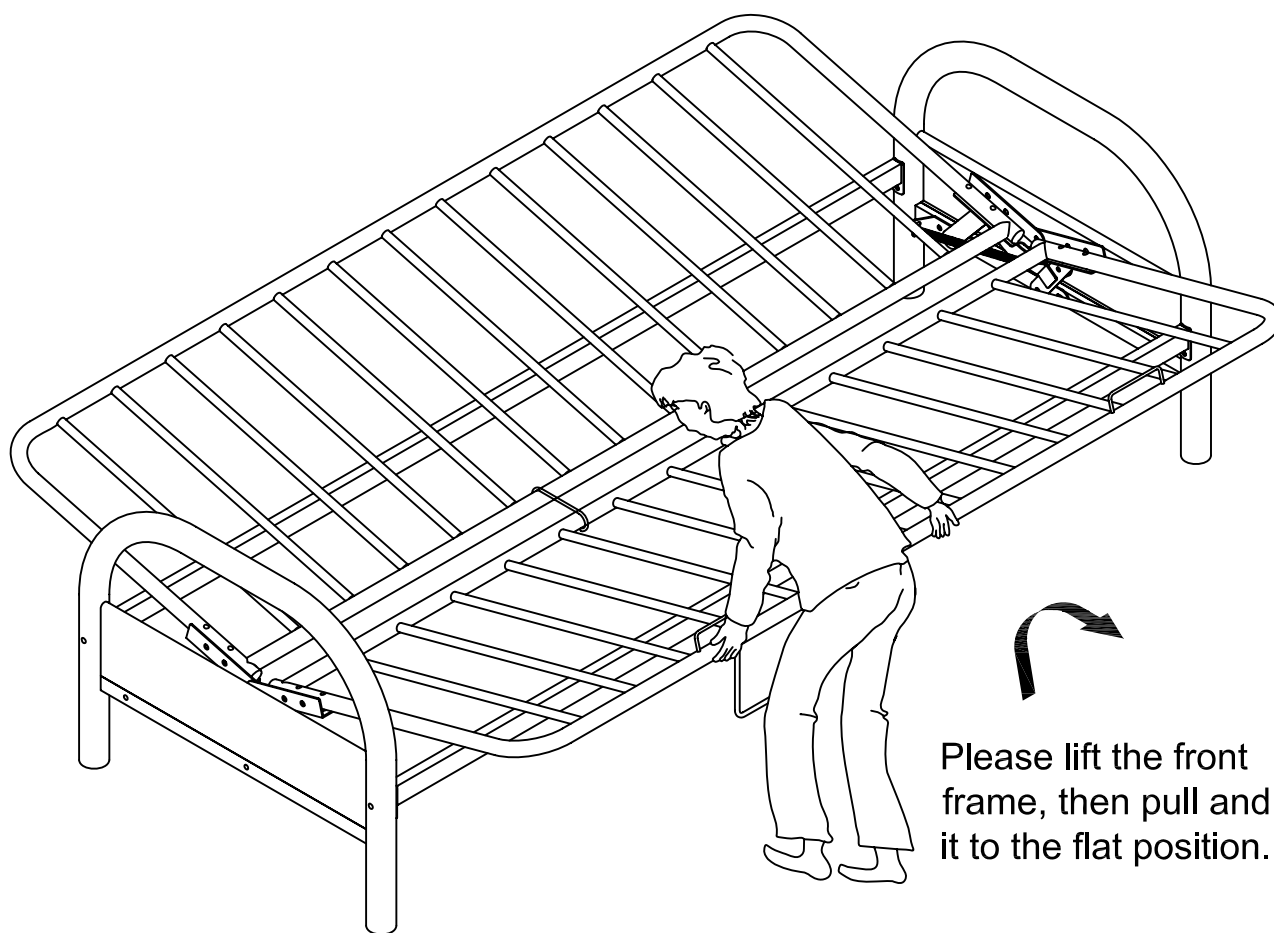

Please lift the front frame, then pull and put it to the flat position.

Assembled view:

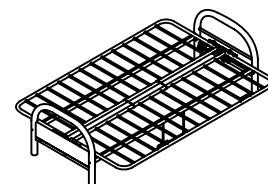

STEP 6

Follow the instruction cited below to return the bed to the seated position.

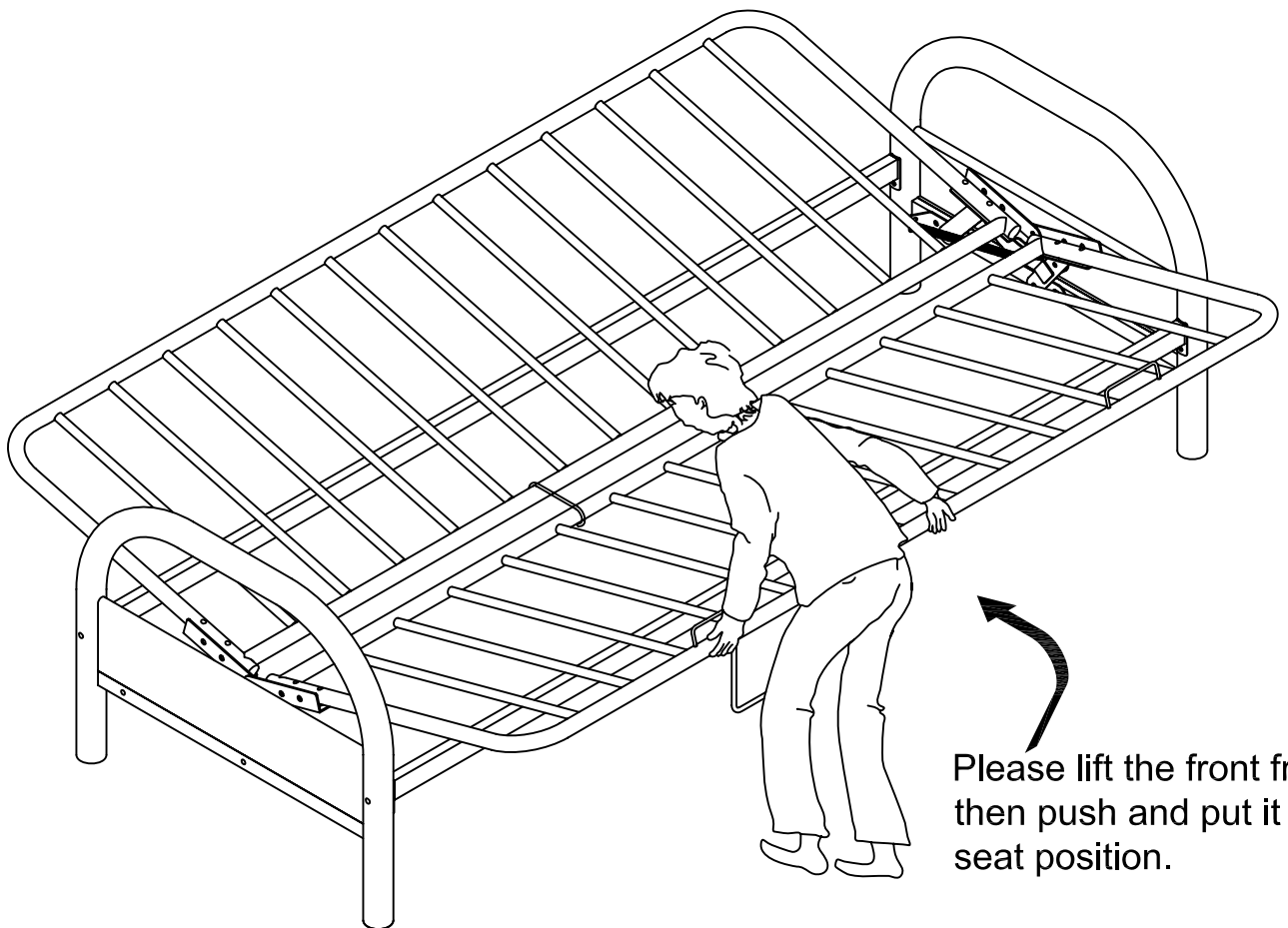

Please lift the front frame, then push and put it to the seat position.

Assembled view:

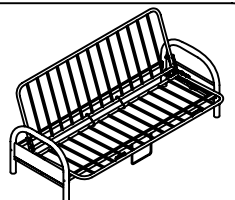

WARNINGS:

- Do not remove warning label from bed.
- Use only mattress which is 74"~75" long and 53-1/2"~54-1/2" wide.
- Do not allow horseplay on or under the bed and prohibit jumping on the bed.
- Periodically check and ensure that all the components are in their proper position, in undamaged condition, and that all connectors are tight.
- Do not use unapproved replacement parts, contact manufacturer or dealer for replacement part.
- Maximum total weight can not exceed 400 lbs.
- **Keep this assembly instruction for future reference.**