

**REPLACEMENT CANOPY SOUTHBAY HEX GAZEBO
ASSEMBLY INSTRUCTION
ITEM NO#: A111005500
SKU#: 810461197**

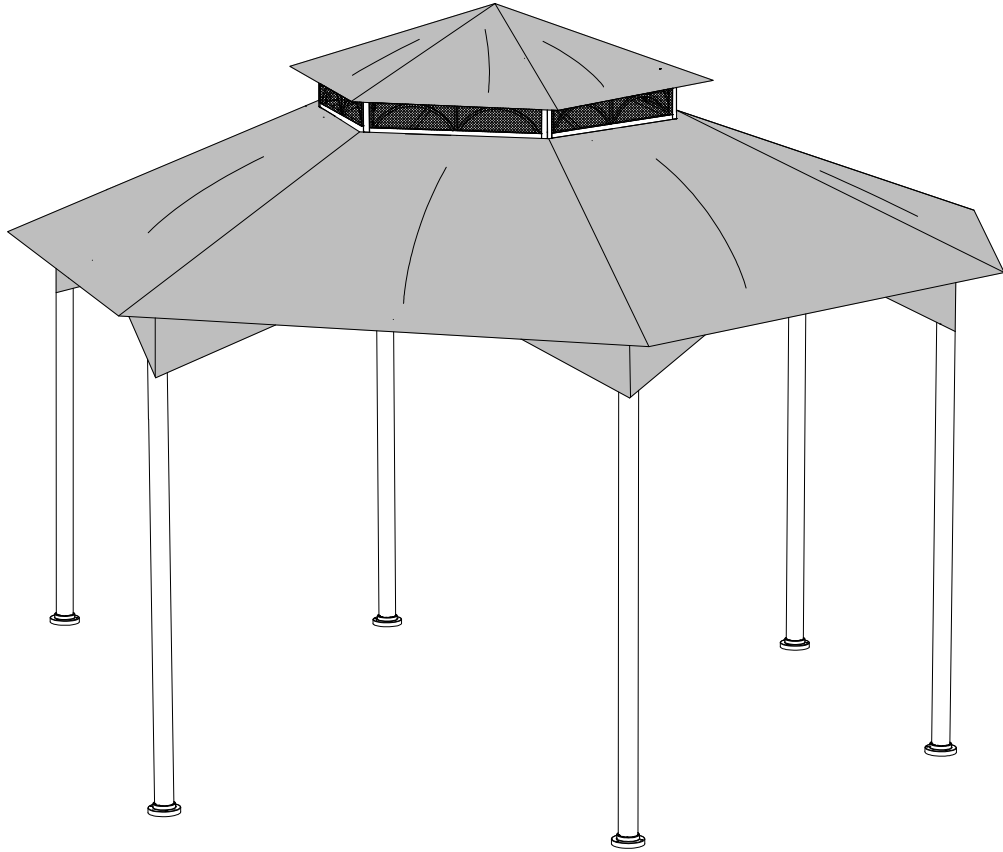

We have you in mind, let us help you!

*** DO NOT RETURN YOUR PRODUCT TO THE STORE *
Contact US FIRST**



1-(866)-578-6569

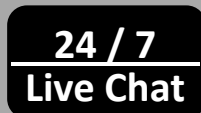

www.sunjoyonline.com



biglots@sunjoygroup.com

Safety Information

- **More than one person** is required for this assembly.
- Some parts may contain sharp edges. Wear protective gloves.
- When assembling and using this product, basic safety precautions should always be followed to reduce the risk of personal injury and damage to equipment. Please read all instructions before assembly and usage.



WARNING: Do not leave the gazebo where there is a risk of high wind, as possible damage will occur to the structure.



WARNING: Keep all flame and heat sources away from this gazebo fabric. This Gazebo is made with fabric that meets CPAI-84 specifications for flame resistance. It is not fire proof. The fabric will burn if left in continuous contact with any flame source. The application of any foreign substance to the gazebo fabric may render the flame-resistant properties ineffective.

NOTICE: For outdoor use

Warranty: 1 Year

WHAT IS COVER?

The limited warranty is extended to the original purchaser and applies to material and manufacturer's defect provided the item is maintained with care and used only for personal, residential purposes.

IMPORTANT

KEEP THIS INSTRUCTION MANUAL FOR FUTURE REFERENCE.

TOOLS NEEDED

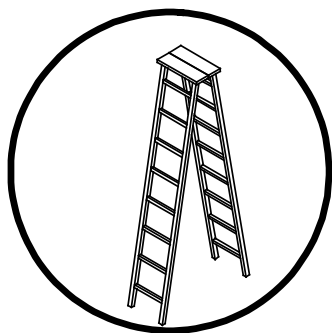

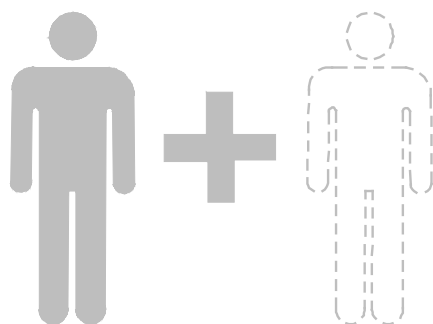

IMPORTANT

How many people needed for the installation work



Country of Origin: China

Call 1(866) 578-6569 for assistance.
Or visit us at www.sunjoyonline.com

Parts List				
Label	Part Number	Description	Qty	Part Image
P	P001100461	Big Canopy	1	
O	P001100460	Small Canopy	1	

Country of Origin: China

Call 1(866) 578-6569 for assistance.
Or visit us at www.sunjoyonline.com

STEP 1: Remove the old canopy

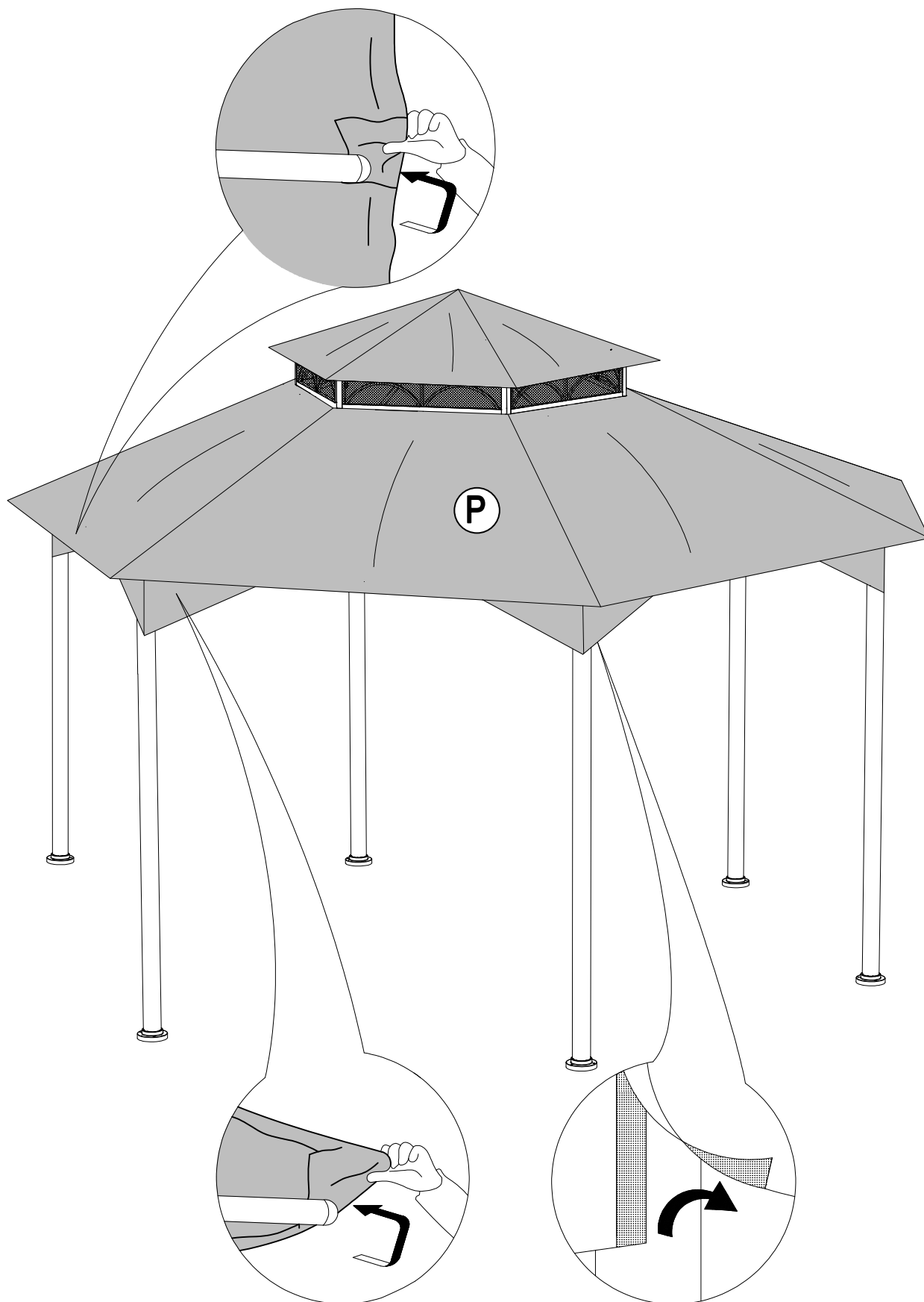

Country of Origin: China

Call 1(866) 578-6569 for assistance.
Or visit us at www.sunjoyonline.com

STEP 2: Remove the small roof

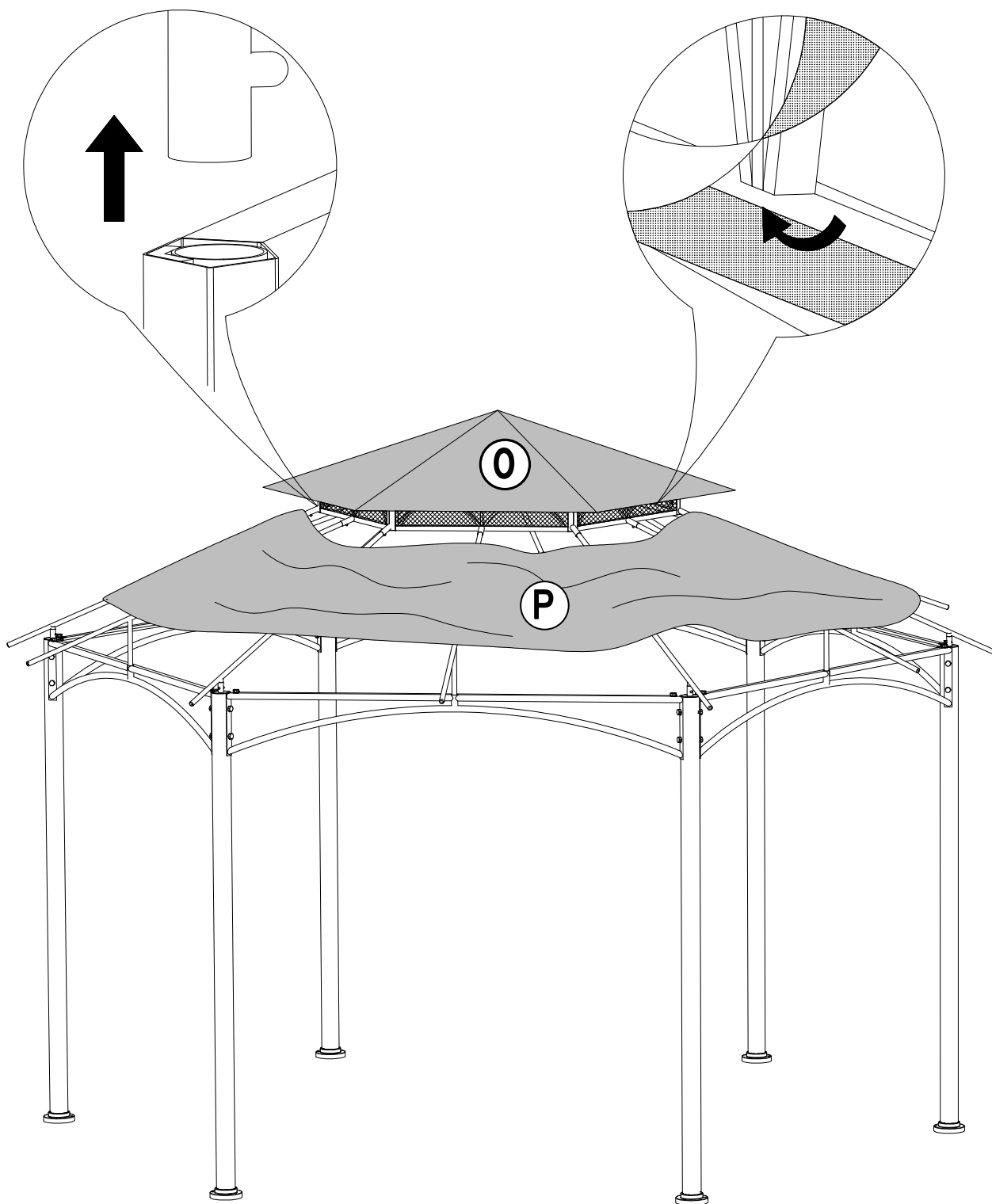

STEP 3: Remove the small canopy

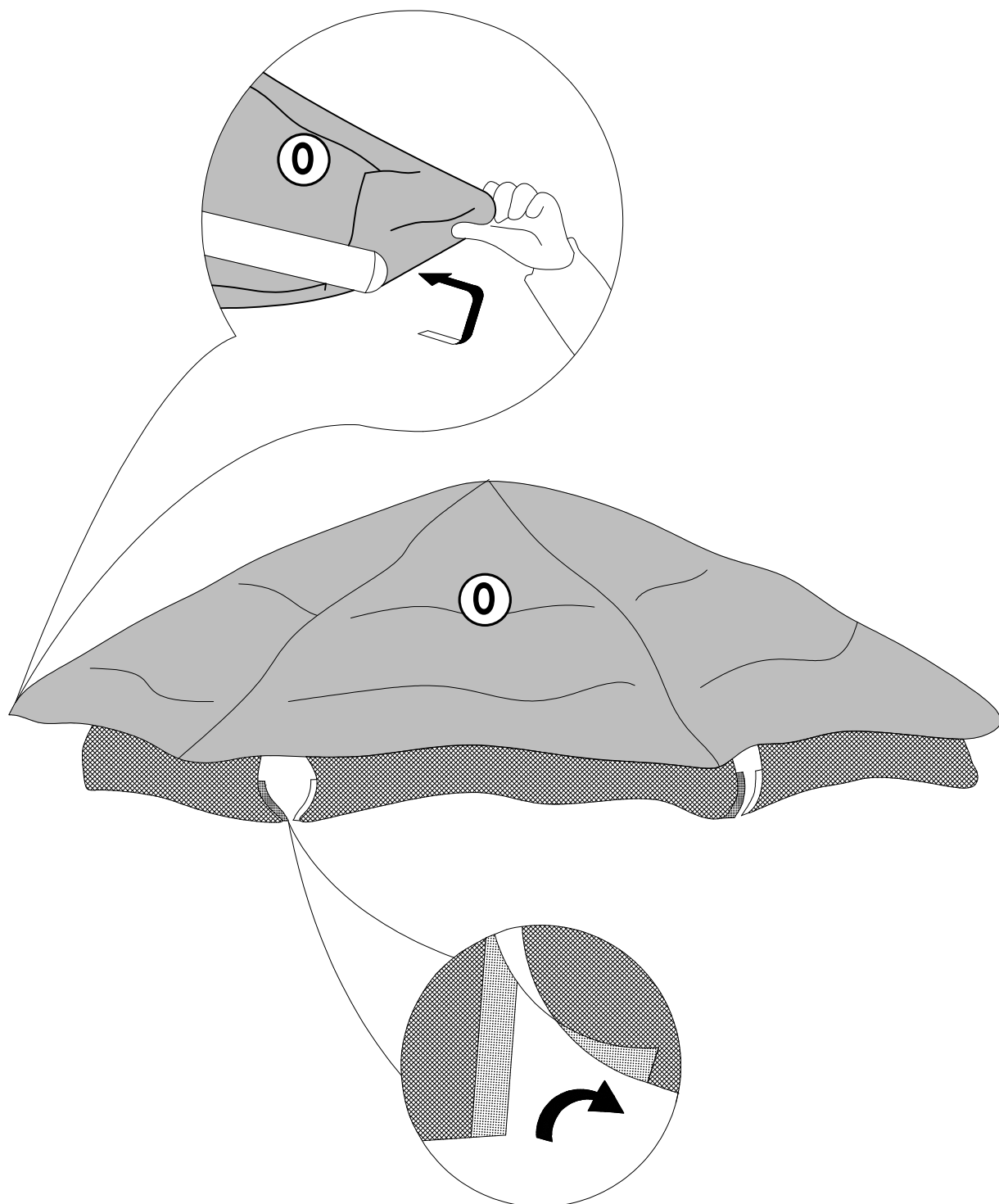

STEP 4: Remove the old canopy

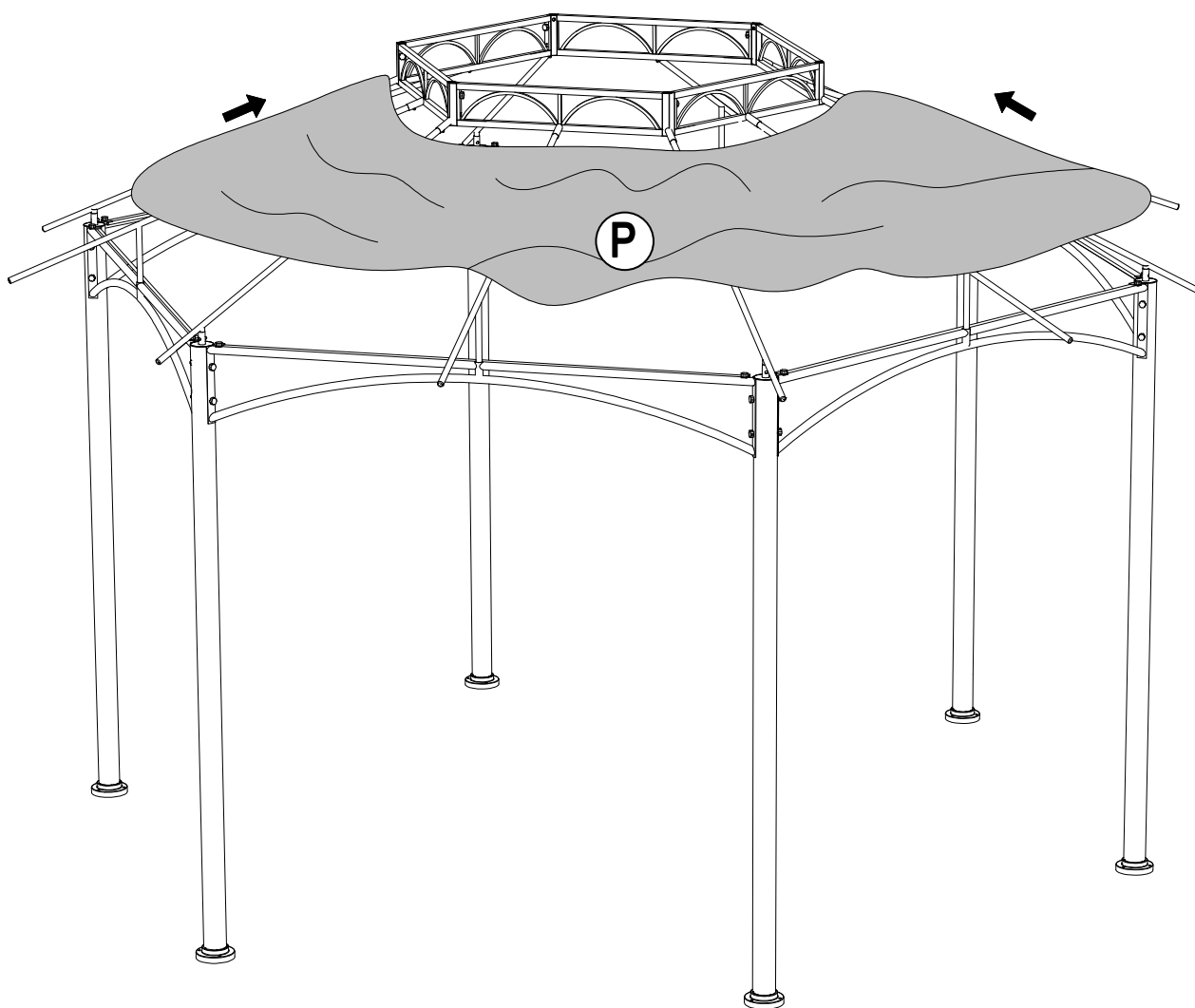

STEP 5: Assemble the new big canopy

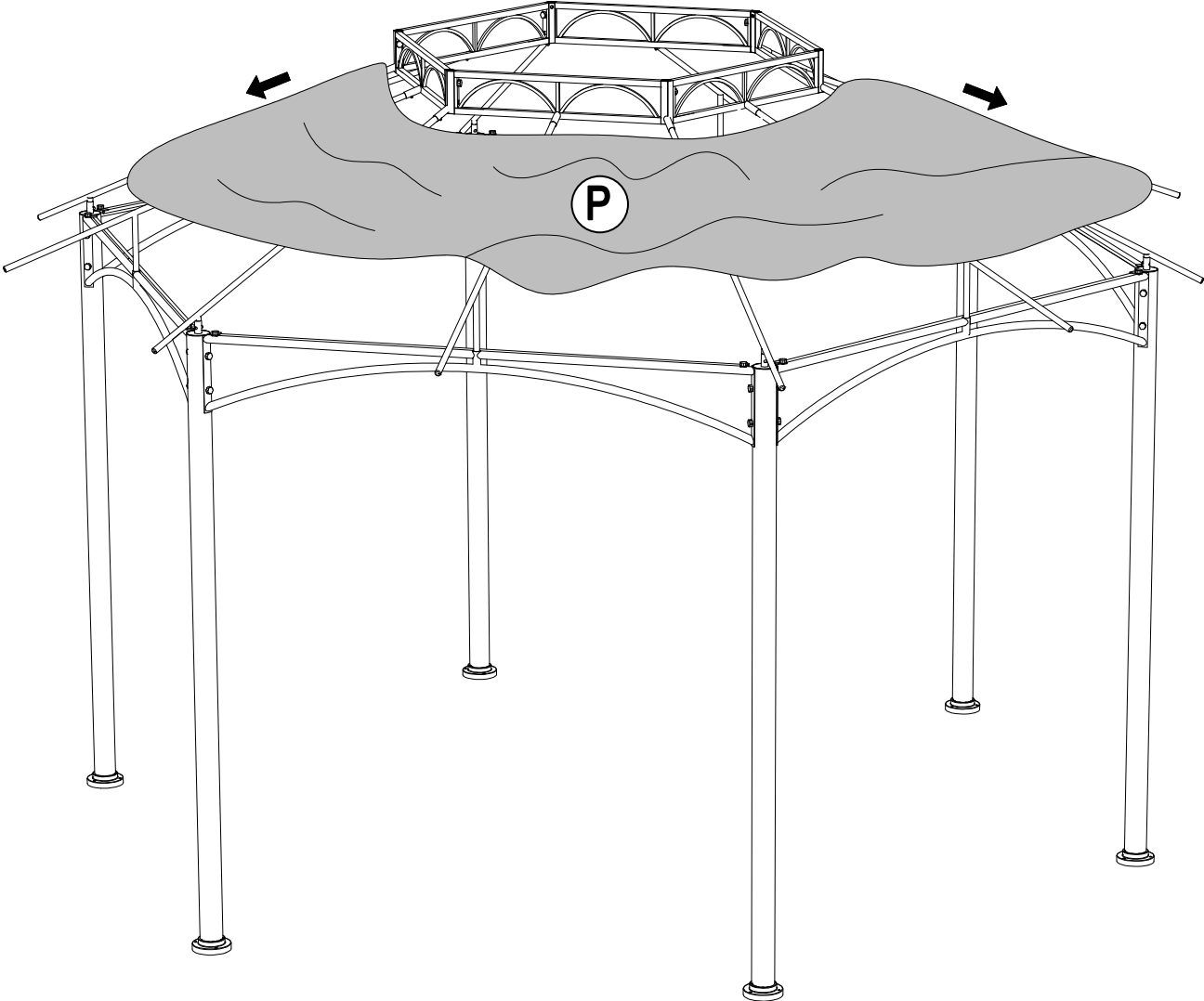
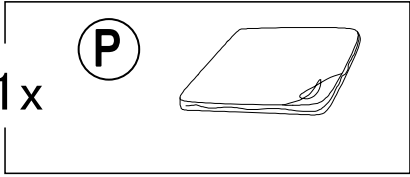

STEP 6: Assemble the new small canopy

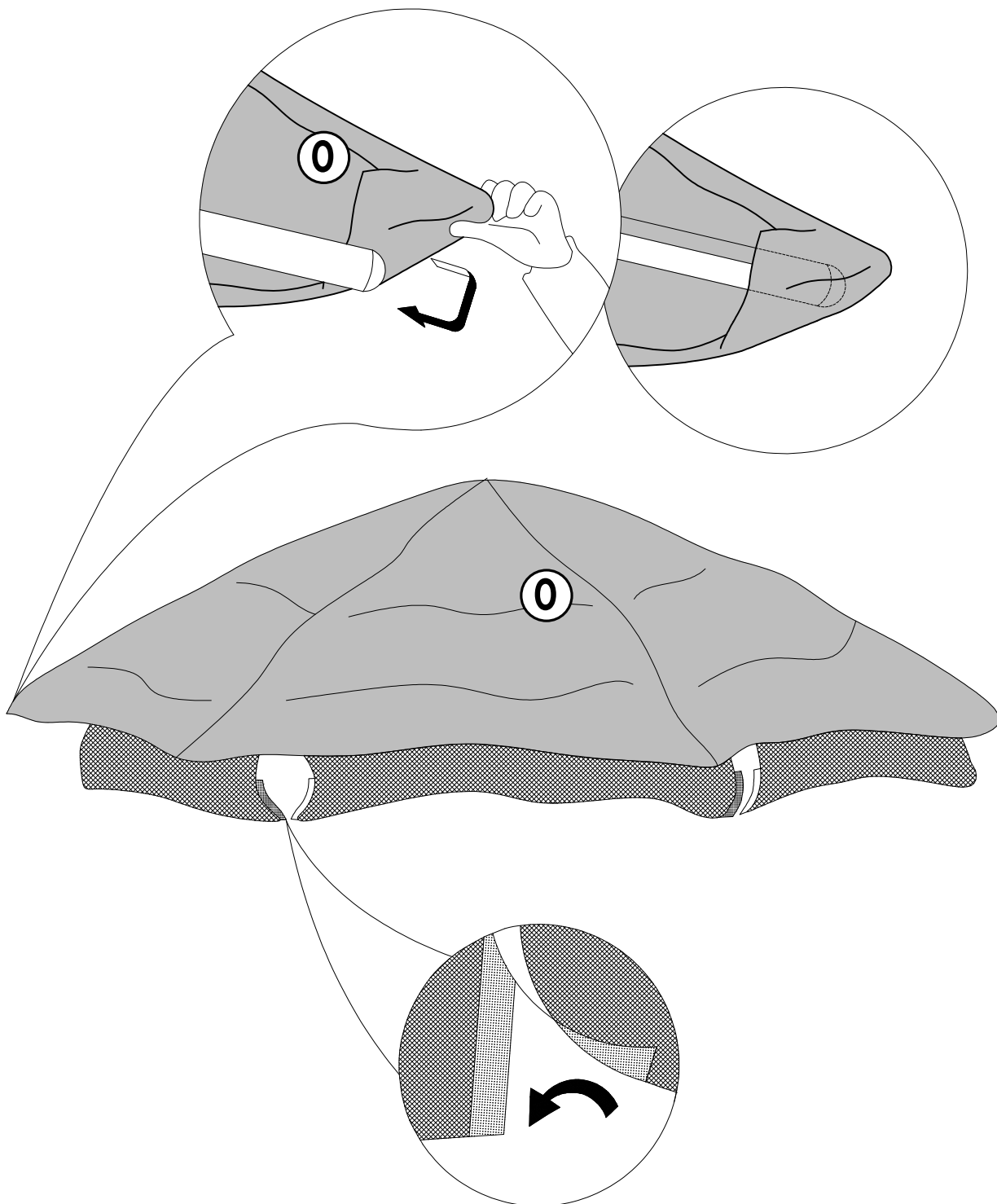
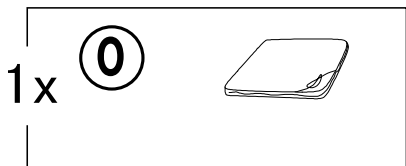

STEP 7: Assemble the small roof

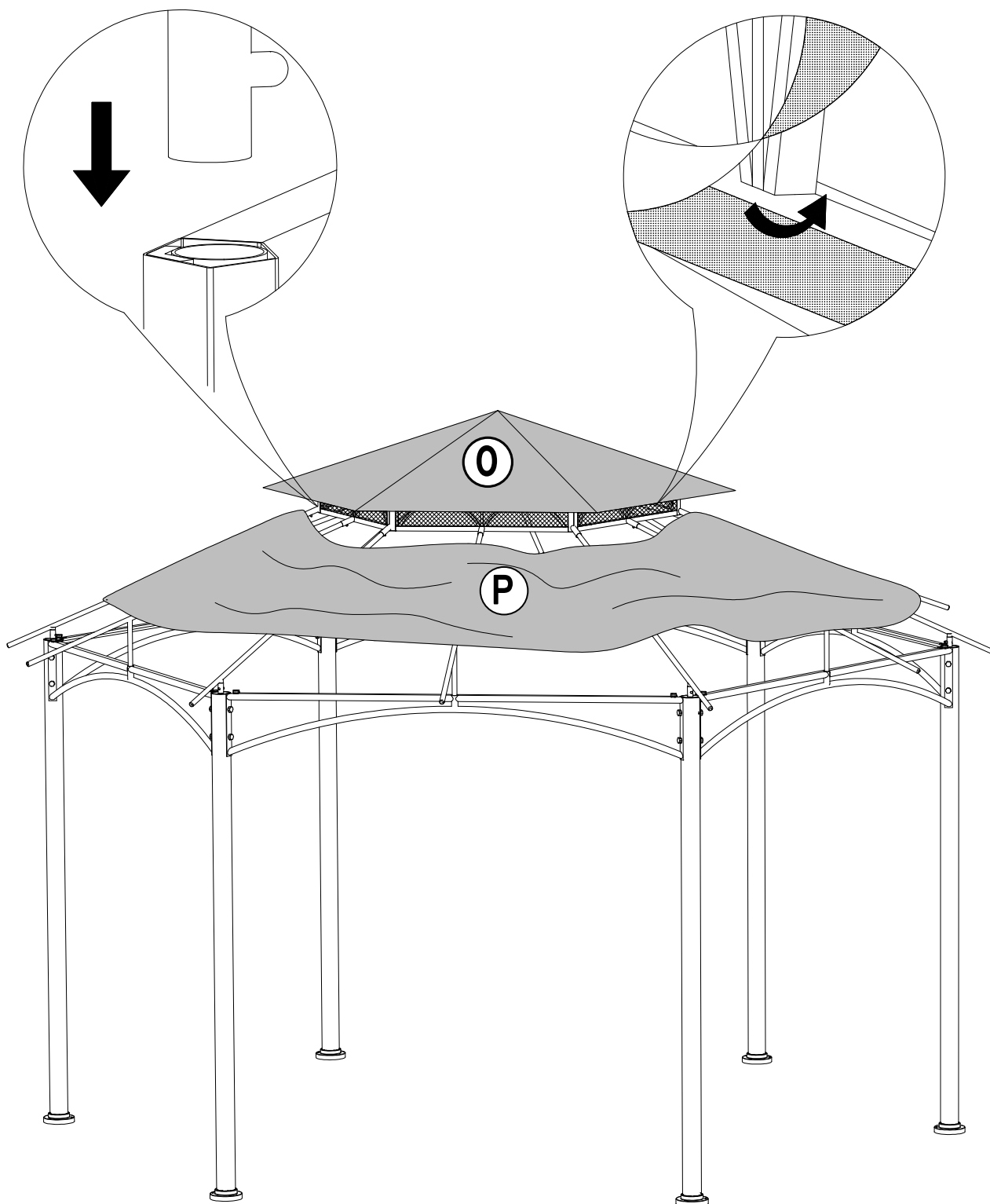

STEP 8: Assemble the new big canopy

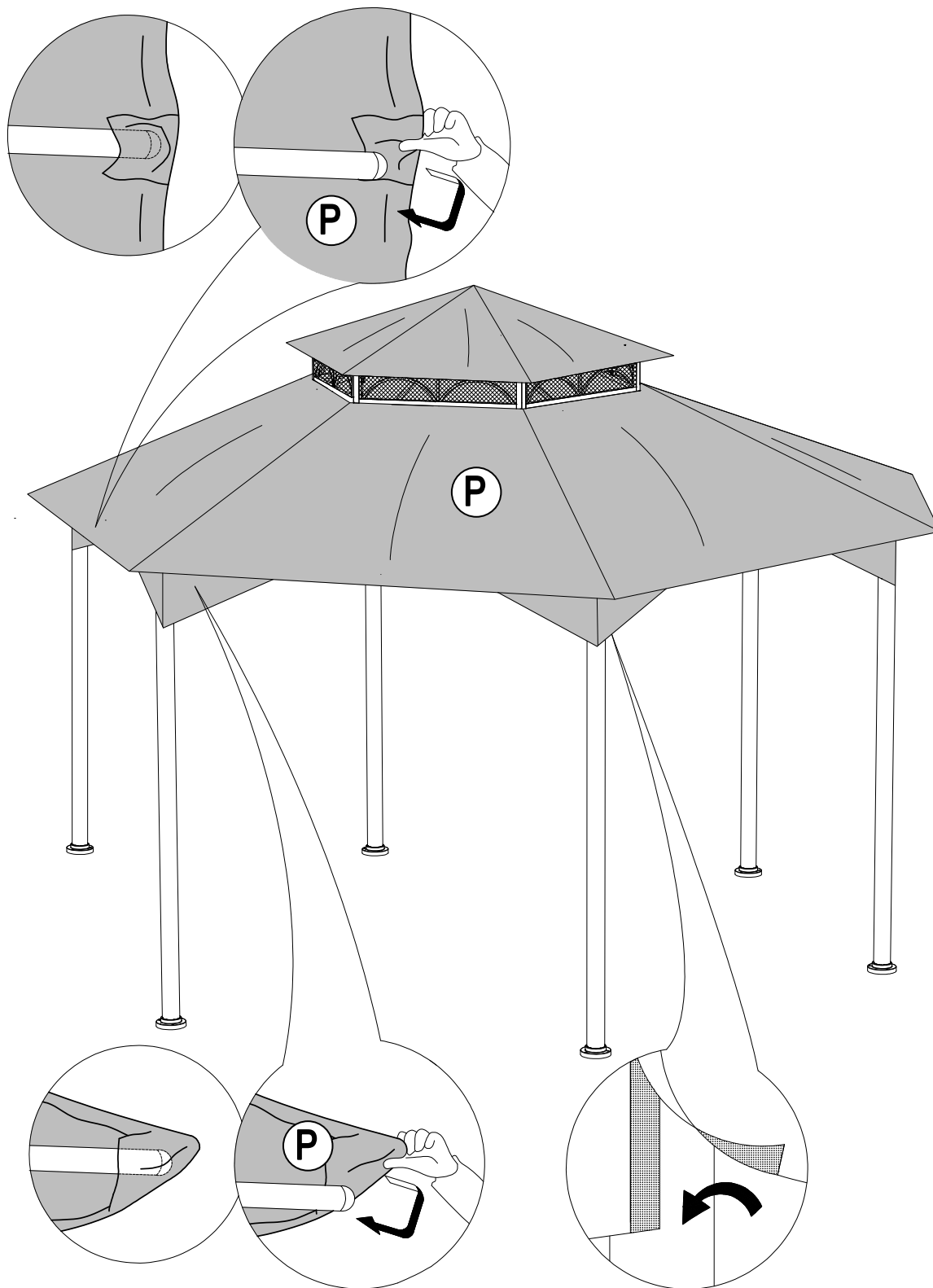

Country of Origin: China

Call 1(866) 578-6569 for assistance.
Or visit us at www.sunjoyonline.com

Care and Maintenance

- Our steel components for garden accessories and furniture are treated with rust inhibiting paint that protects it from rusting. However, due to the nature of steel, surface oxidation (rusting) will occur once these protective coatings are scratched. This is not a defect and thus not covered by the warranty.
- To minimize this condition, we recommend care when assembling & handling the product to prevent scratching the paint. Should any scratching or damage occur, we recommend immediate touch-up with rust inhibiting paint.
- Surface rust can also be easily removed with a very light application of common cooking oil. If surface oxidation (rusting) occurs and if no measure is taken to prevent this, the oxidation may start dripping on to deck or patio and caused damaging stains, which may be difficult to remove. This can be prevented if the above-mentioned measures are taken to keep the product from oxidizing.
- Use damp cloth to wipe off the stains as quickly as possible.
- If necessary, wash with a mild solution of soap and water; rinse thoroughly and dry completely.
- Periodically check and ensure that all bolts are well-tighten during use

Limited Manufacturer's Warranty

Sunjoy Group warrants to the original purchaser that this item is free from defects in workmanship and materials for a period of **1 year** from the date of purchase, provided the item was factory-sealed at the time of purchase and is maintained with care and used only for personal, residential purposes. Should any manufacturing defect arise within this warranty period, Sunjoy Group will replace (at our option) any defective merchandise or parts upon proof of purchase; however, transportation and delivery costs, as well as payments to a third party for assembly or disassembly of the item, remain the responsibility of the purchaser. A purchaser of an "open box," previously-returned, or "clearance" item, as well as original purchasers outside of the warranty period, may obtain replacement parts from Sunjoy Group for products in current production, at nominal cost.

Exclusions:

Items used for commercial, contract, or other non-residential purposes, or items damaged due to acts of nature, vandalism, misuse, or improper assembly are not covered. Corrosion or rusting of hardware is not covered. Proof of purchase (dated register receipt) is required for warranty claims. Warranty is to the original purchaser and is non-transferable. Any replacement of warranted items will be in the original style and color, or a similar style and color if the original is unavailable or has been discontinued. As some states do not allow exclusions or limitations on an implied warranty, the above exclusions and limitations may not apply. This warranty gives you specific rights, and you may also have other rights, which vary from state to state.