

## ASSEMBLY INSTRUCTIONS

ITEM#: A106004504

SKU# 810490384

---

# MADISON PERGOLA

---

Need help? We are here for you! 1(866)578.6569 24/7 • Toll Free

---

---

# GENERAL BEST PRACTICES FOR ASSEMBLY:

---

---

- Please read and understand this entire manual before attempting to assemble or install the product.
  - Before beginning assembly of product, make sure all parts are present. Compare parts with package contents list and hardware contents list. If any part is missing or damaged, do not attempt to assemble the product.
  - The assembled gazebo should be located at least 6 feet from any obstruction such as fence, garage, house, overhanging branches, laundry lines or electrical wires.
  - Some parts may contain sharp edges. Wear protective gloves if necessary, during assembly.
  - This unit is heavy. For safety, do not assemble this item alone. Four people are recommended for safe assembly.
  - Check all nuts and bolts periodically for tightness and, when required, tighten them again.
  - Pay attention to the parts orientation
- 
- 

## WARNINGS:

---

---

- Install the gazebo on level ground. Stakes are provided to secure the gazebo to the ground.
  - Do not assemble the gazebo on sandy, muddy or loose soil, as stakes do not have enough anchorage in these types of soil.
  - If you wish to secure the gazebo to a wood deck or concrete surface, use anchors suited to these surfaces.
  - Snow must be cleared off regularly during snowy days. Remove the snow at the roof top when it is thicker than 2 inches. In order to avoid damage, use a plastic snow rake to remove excessive snow and ice buildup from roof and keep away from falling debris.
  - Do not leave the gazebo where there is a risk of high wind, as possible damage will occur to the structure.
  - Any assembly or maintenance of the product must be carried out by adults only.
  - Please check your state and local regulations prior to purchasing. Some jurisdictions may require permits for installation and use. Some special procedures may be valid in your area.
  - Keep all flame and heat sources away from the tent fabric. This tent is made with fabric that meets CPAI-84 specifications for flame resistance. It is not fire proof. The fabric will burn if right in continuous contact with any flame source. The application of any foreign substance to the tent fabric may render the flameresistant properties ineffective.
  - If any scratch paint, please touch up to prevent rusting
  - For outdoor use only.
- 
- 

## WARRANTY:

---

---

### WHAT IS COVERED?

The limited warranty is extended to the original purchaser and applies to material and manufacturer's defect provided the item is maintained with care and used only for personal, residential purposes.

Warranty: 1 Year

---

---

## MAINTENANCE:

---

---

- Steel components for this gazebo are treated with rust inhibiting paint that protects it from rusting. However, due to the nature of steel, surface oxidation (rusting) will occur if these protective coatings are scratched. This is not a defect and thus not covered by the warranty.
- To minimize this condition, it is recommended to use care when assembling and handling the product to prevent scratching the paint. Should any scratching or damage occur, it is recommended to cover the scratch immediately with rust inhibiting paint (not included).
- Surface rust can also be easily removed with a very light application of regular cooking oil or WD-40. If surface oxidation (rusting) occurs and if no measure is taken to prevent this, the oxidation may start dripping onto deck or patio and caused damaging stains, which may be difficult to remove. This can be prevented if the above-mentioned measures are taken to keep the product from oxidizing.
- Do not use bleach, acid, or other abrasive cleaners on the roof or frame parts.
- Keep instruction manual for future reference.
- Keep the original packaging to store the gazebo.
- Periodically check and ensure that all bolts are well-tighten during use

---

---







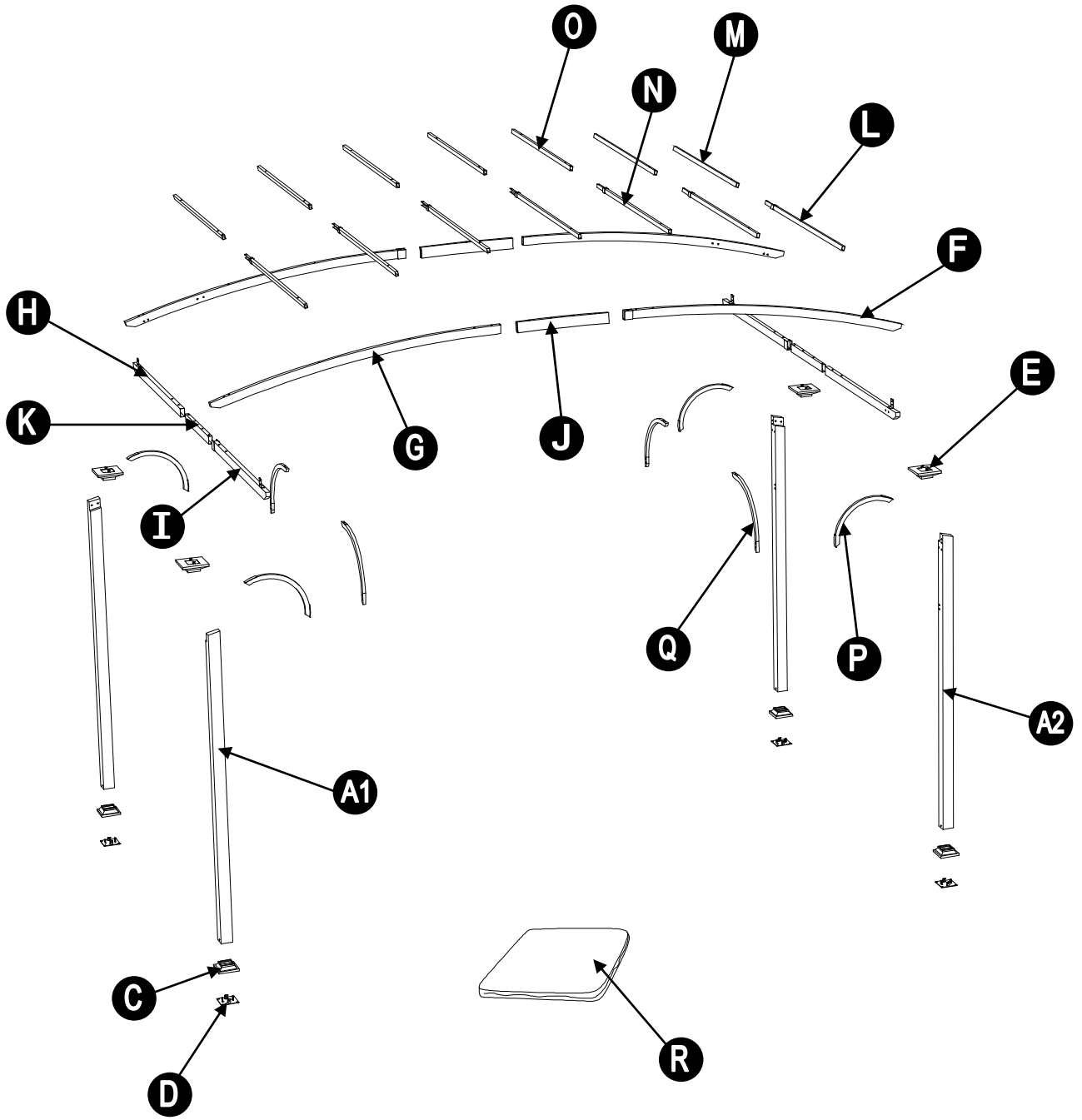







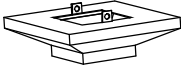
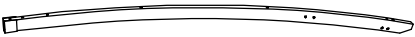

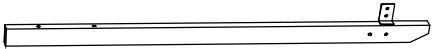
# EXPLODED DRAWING

---



---



# PARTS LIST

Label	Part Number	Description	Qty	Part Image
A1	P000200422	Post 1	2	
A2	P000200423	Post 2	2	
C	P006100092	Base Cover	4	
D	P000100152	Base	4	
E	P005600124	Post Decoration	4	
F	P000400527	Arc Beam1	2	
G	P000400528	Arc Beam2	2	
H	P000400961	Short side beam	2	
I	P000400962	Long side beam	2	
J	P000500614	Arc Beam Connector	2	
K	P000500615	Beam Connector	2	
L	P000600740	Side Small Beam1	2	
M	P000600742	Side Small Beam2	2	
N	P000600739	Middle Small Beam1	5	
O	P000600741	Middle Small Beam2	5	
P	P005000206	Arc Support Bar	4	
Q	P005000209	Short Side Arc Support Bar	4	
R	P001100298	Canopy	1	

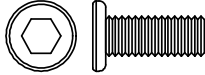
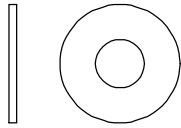
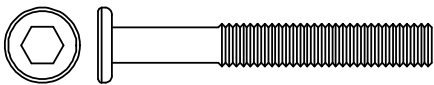
# HARDWARE LIST

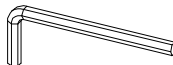
Label	Part Number	Description	Qty	Add	Part Image
AA	H010030030	Bolt M6*15	58	3	
BB	H050030001	Flat washer M6	120	6	
EE	H010030036	Bolt M6*45	62	3	
GG	H070010003	Stake Φ8 *180	8	0	
Z1	H090030002	Wrench M6	2	0	

---

---

# HELPFUL HINTS

---

---

- Tools needed and not included:
- How many people needed for the installation work

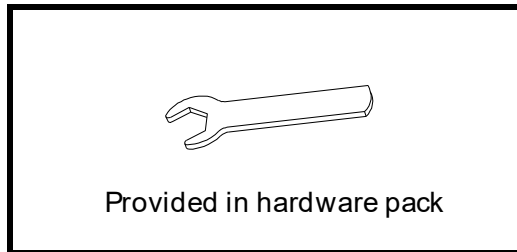
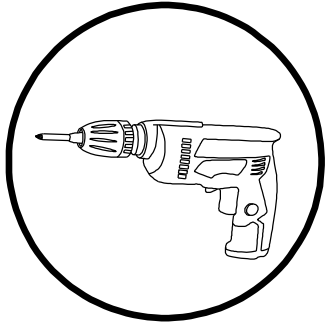
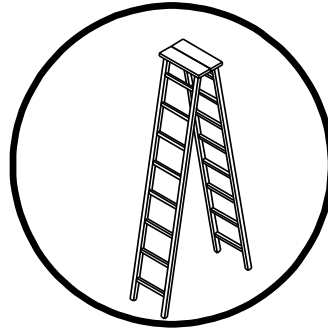
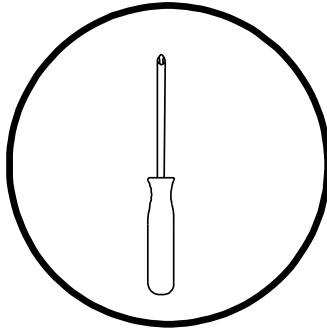
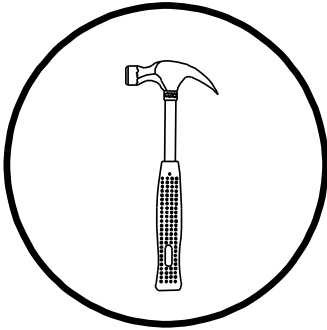

## How many people needed for the installation work

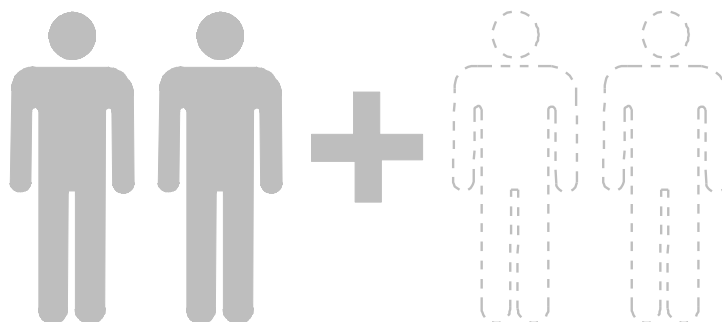

# STEP 1

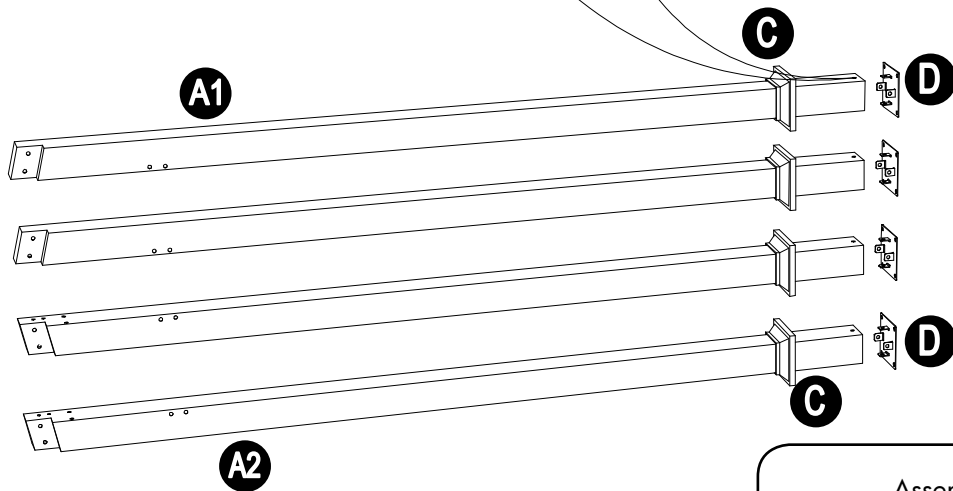
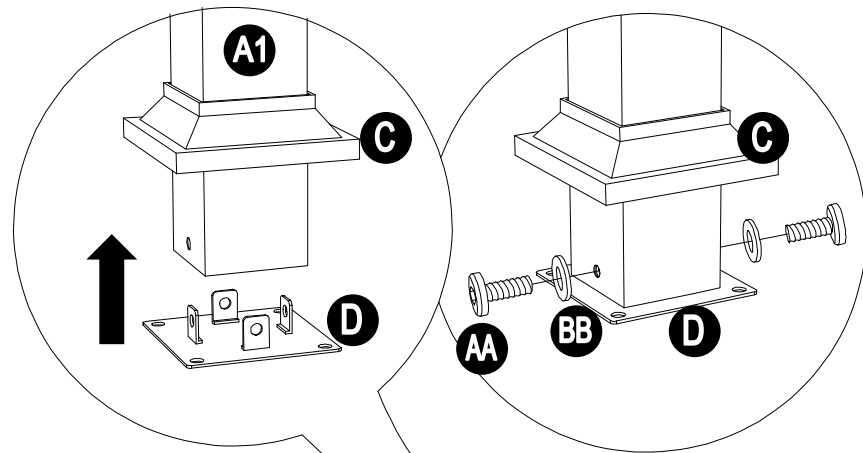
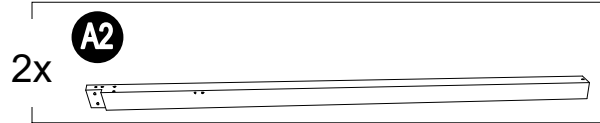
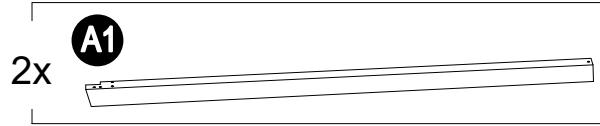
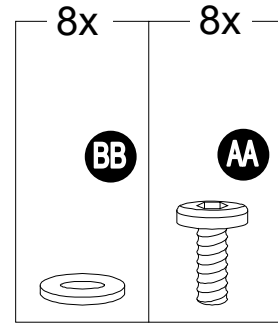
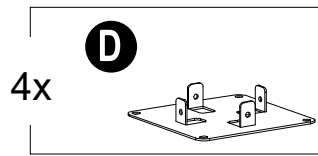
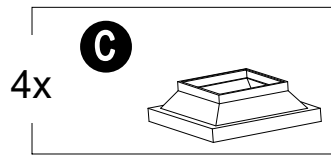

Assembled View:

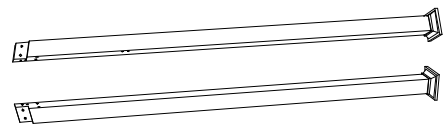

Attach the Base Cover (C) and Base(D) to the Post(A1,A2) by Bolt(AA) , Flat Washer(BB) and Wrench(Z1)

# STEP 2

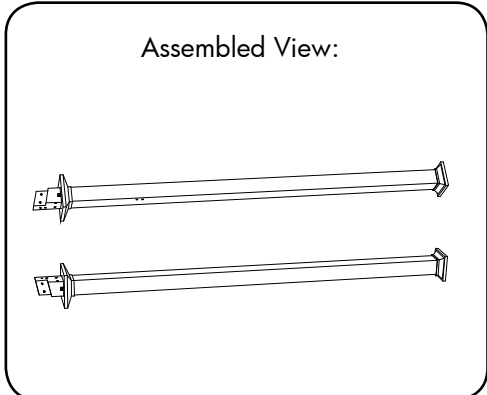
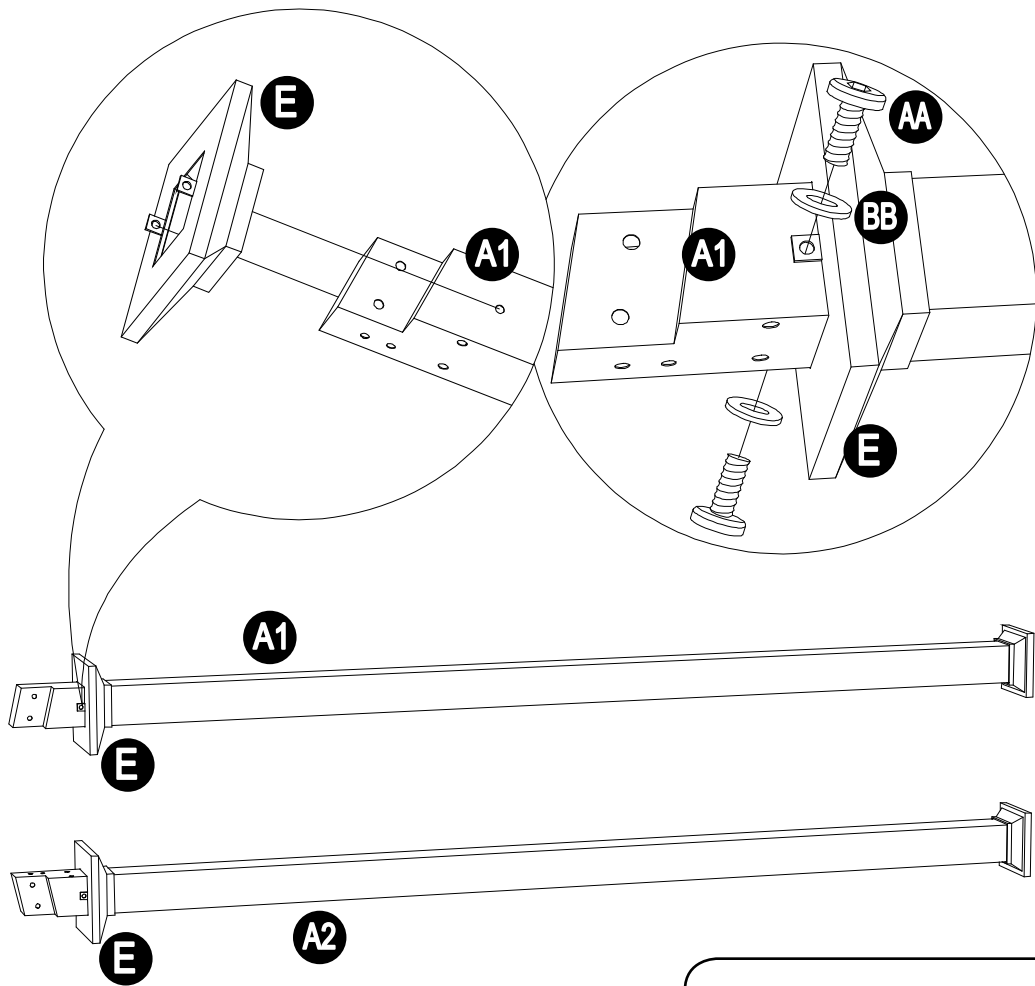
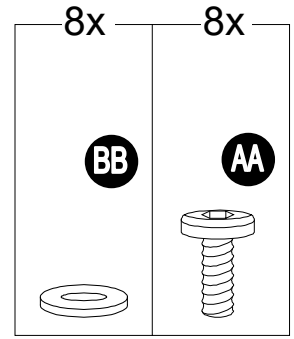
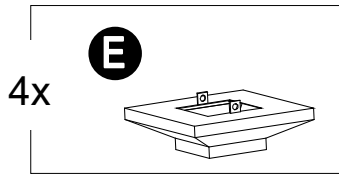

Attach the Post Decoration(E) to Post(A1, A2) by Bolt(AA), Flat Washer(BB) and Wrench(Z1)



# STEP 3

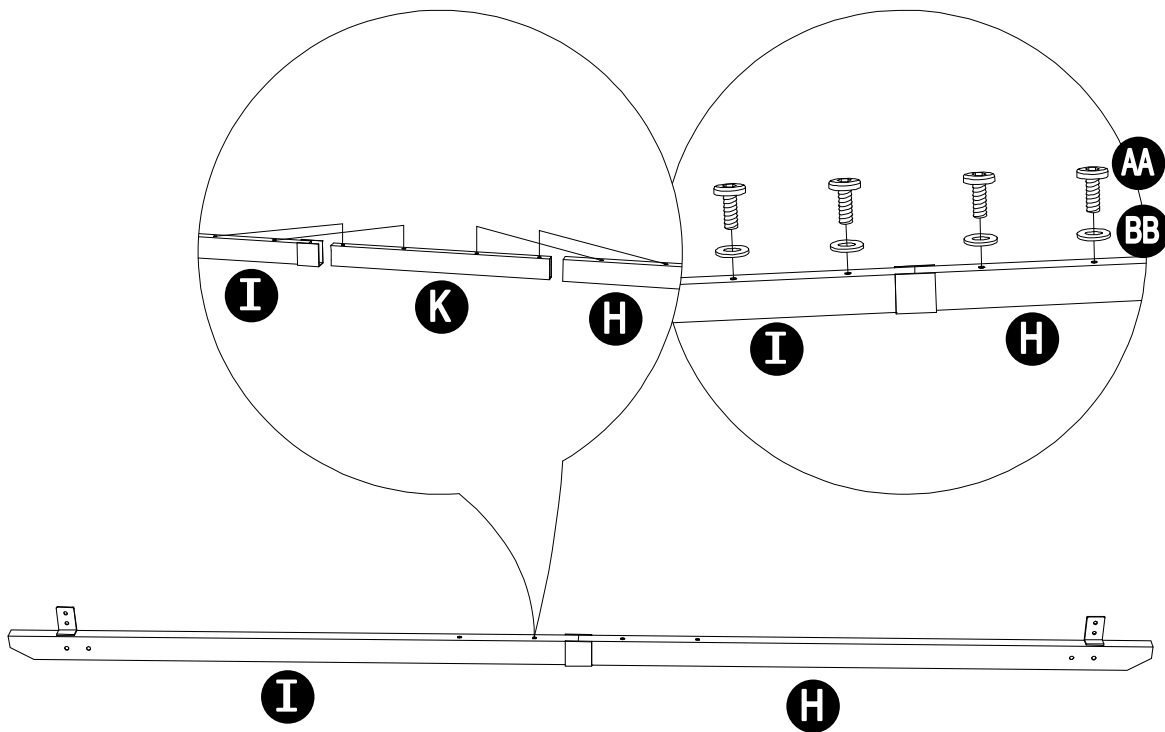
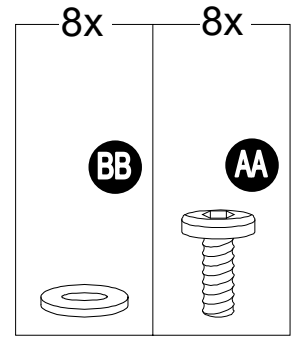
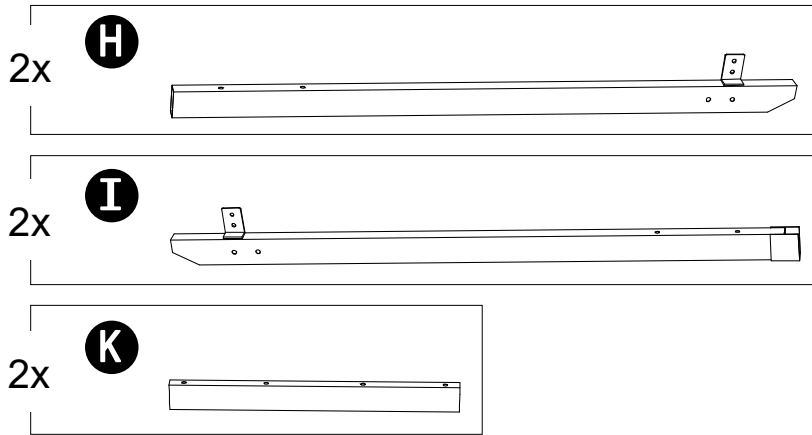

Attach the Short Side Beam(H) through Beam Connector(K) to Long Side Beam by Bolt(AA), Flat Washer(BB) and Wrench(Z1)

Assembled View:



# STEP 4

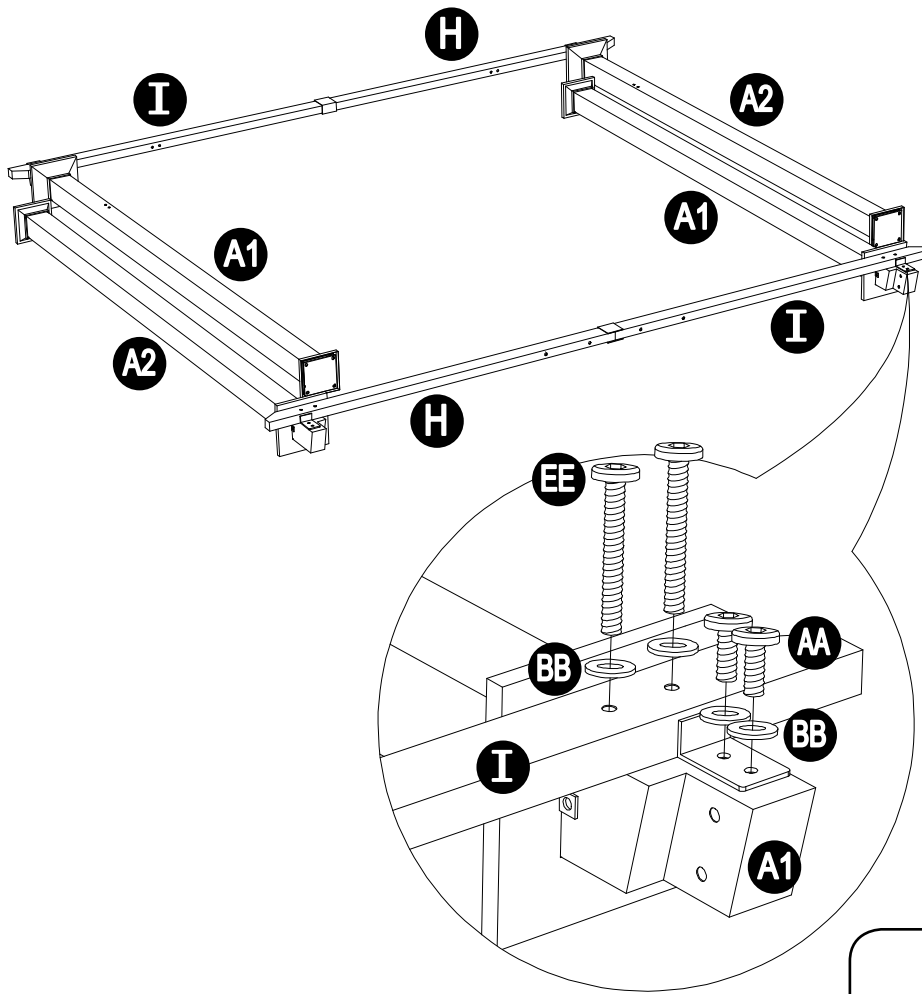
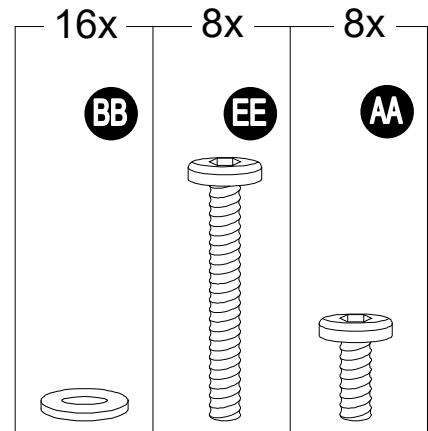

Attach the assembled Beam(H,K,I) to Post(A1, A2) by Bolt (AA,EE) and Wrench(Z1)

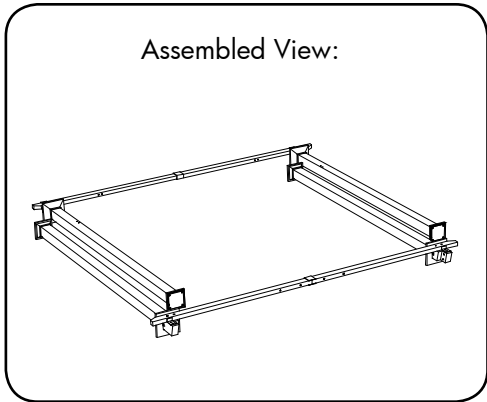

# STEP 5

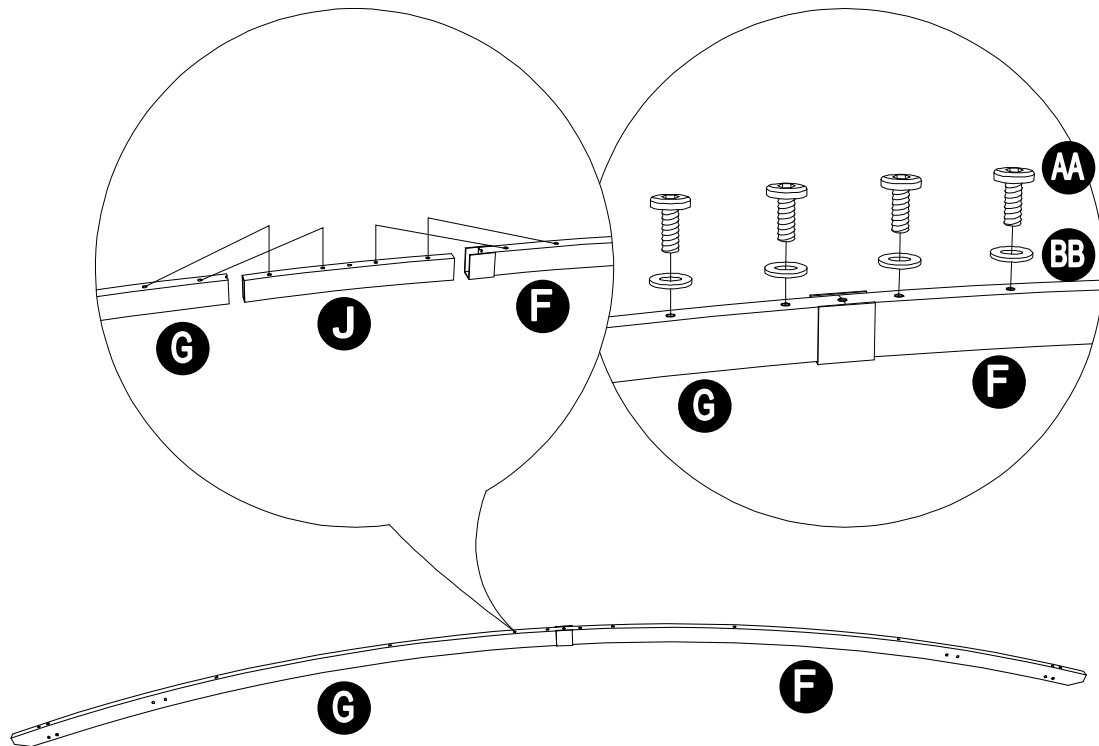
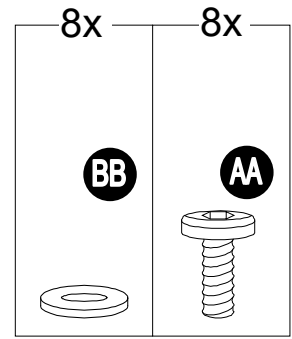
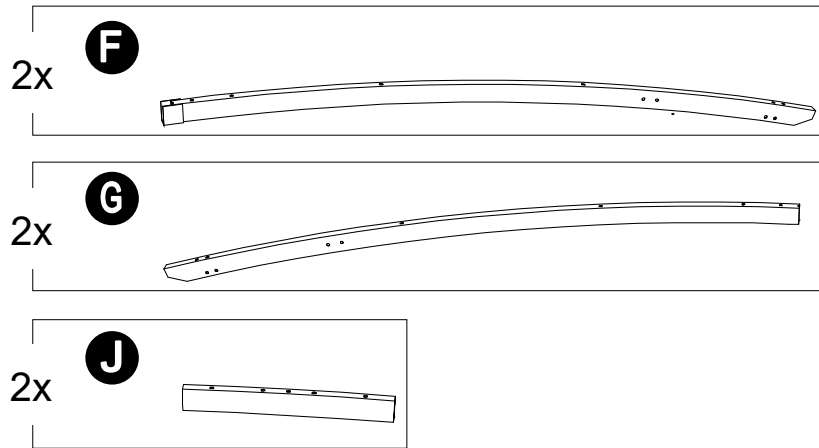

Attach the Arc Beam1(F) through Arc Beam Connector(J) to Arc Beam2(G) by Bolt(AA), Flat Washer(BB) and Wrench(Z1)

Assembled View:



# STEP 6

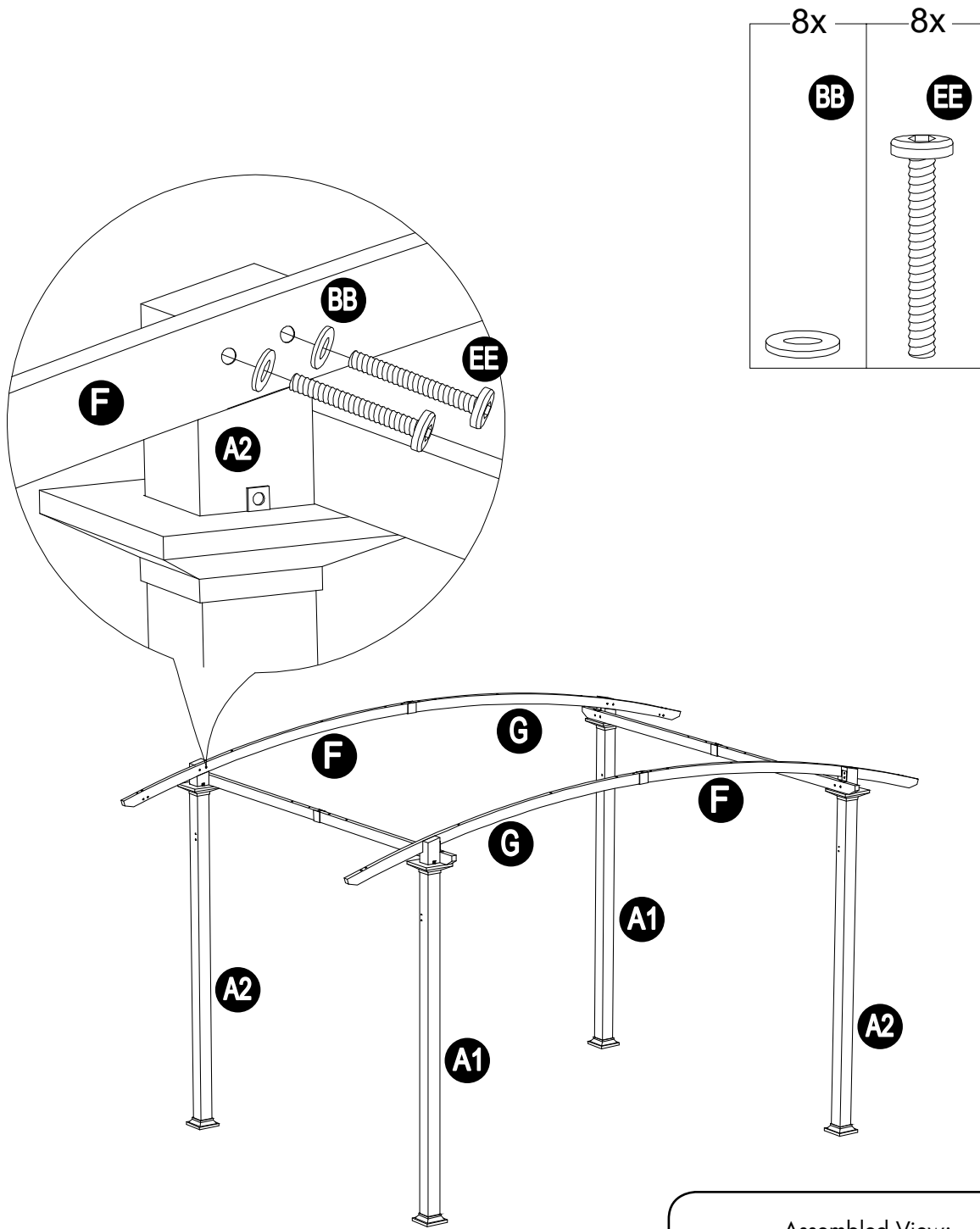

Attach the assembled(F,J,G) to the Post(A1, A2) by Bolt(EE), Flat Washer(BB) and Wrench(Z1)

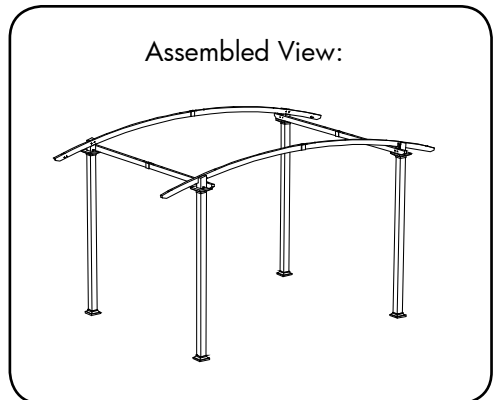

# STEP 7

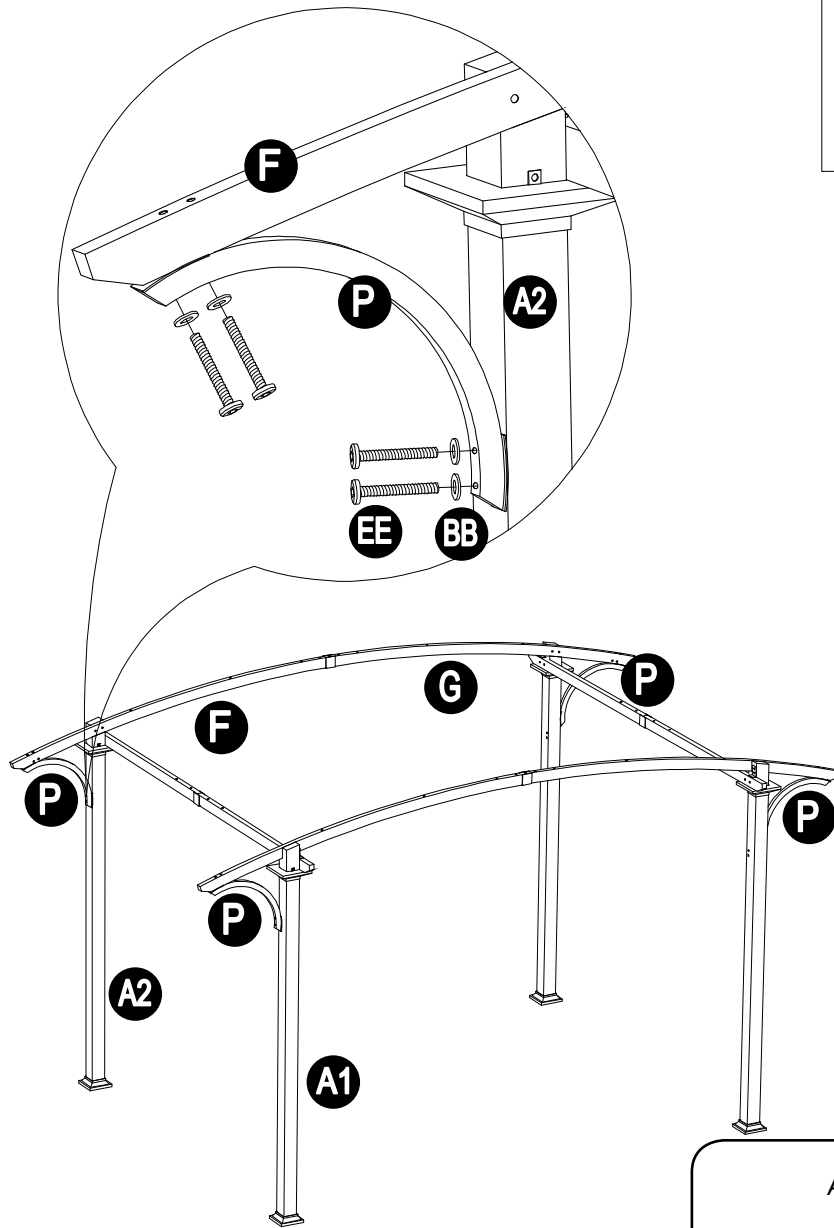
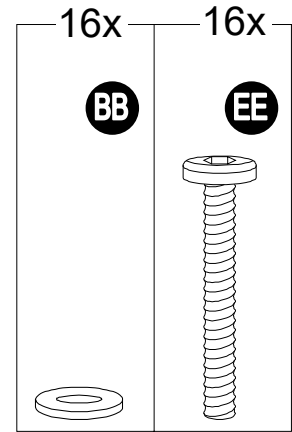
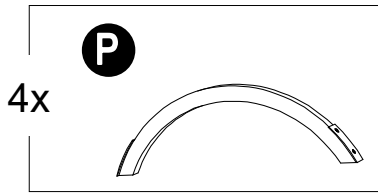

Assembled View:

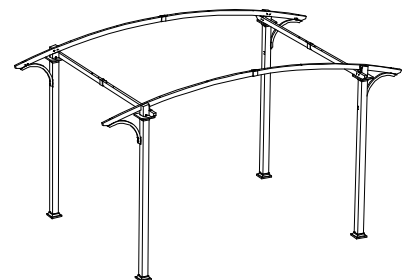

Attach the Arc Support Bar(P) to Post(A1, A2) and Arc Beam(F,G) by Bolt(EE), Flat Washer(BB) and Wrench(Z1)

# STEP 8

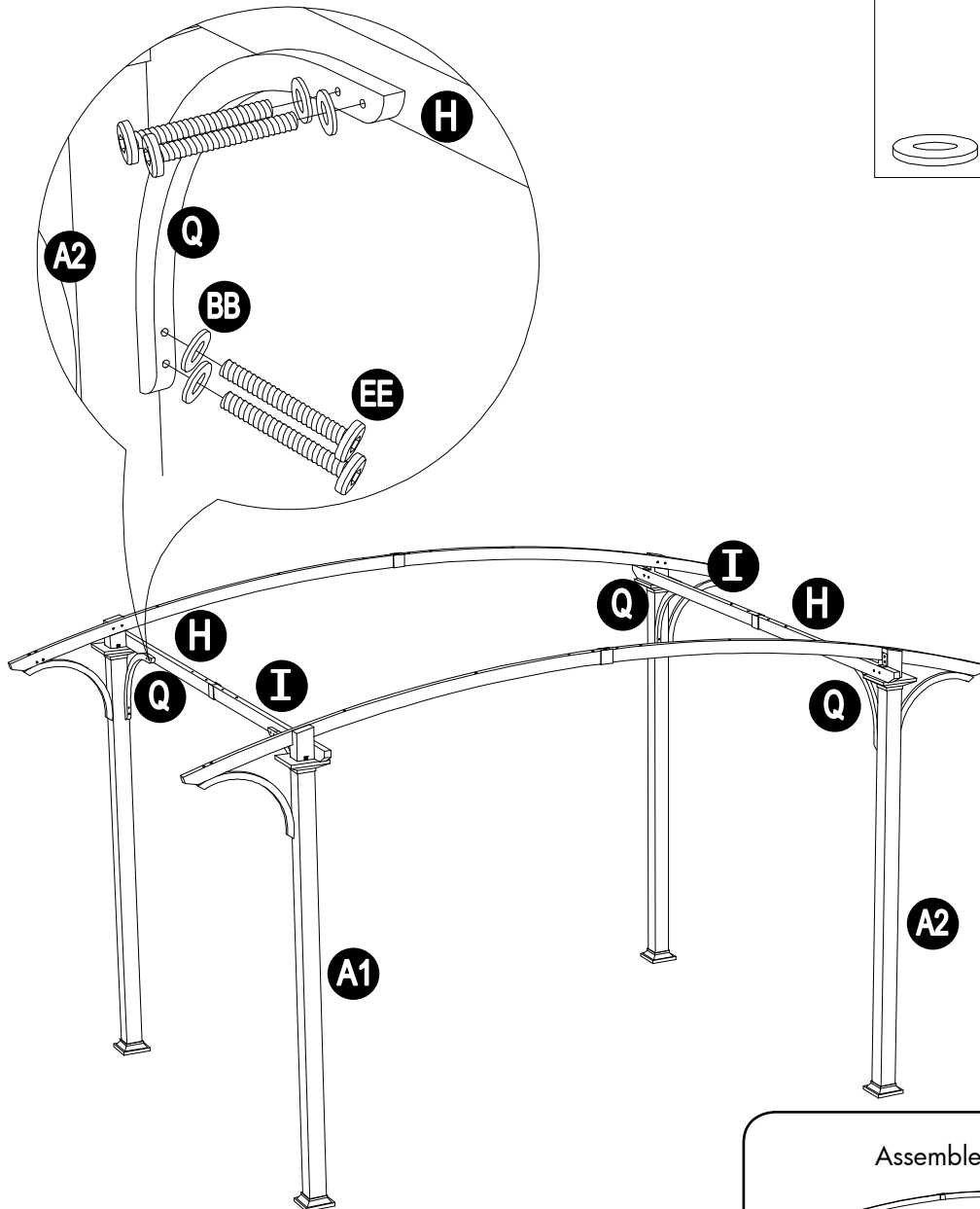
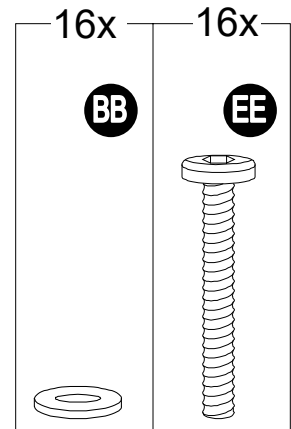
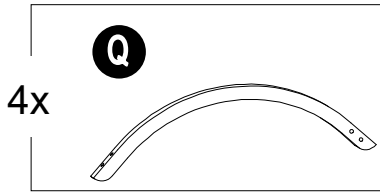

Assembled View:

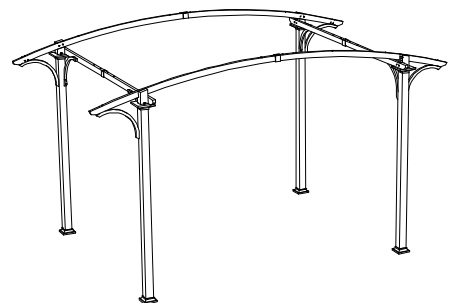

Attach the Short Side Arc Support Bar(Q) to the Post(A1, A2) and Side Beam (H, I) by Bolt(EE), Flat Washer(BB) and Wrench(Z1)

# STEP 9

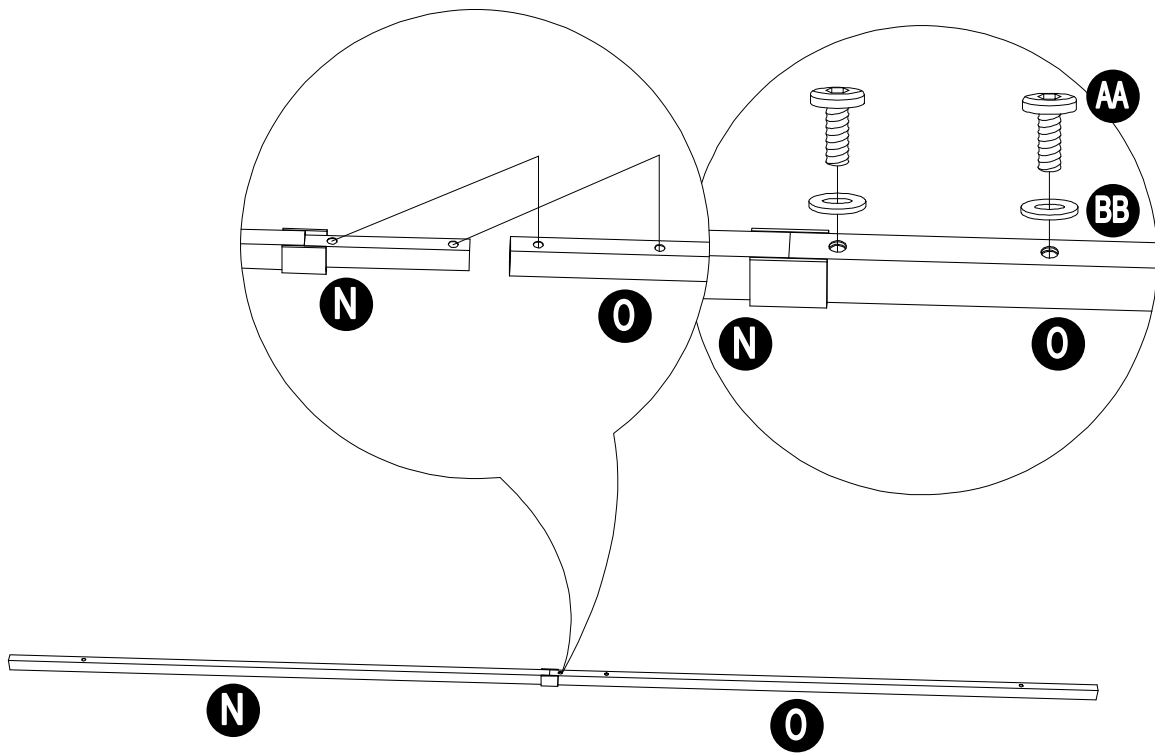
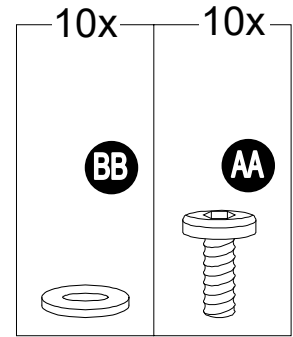
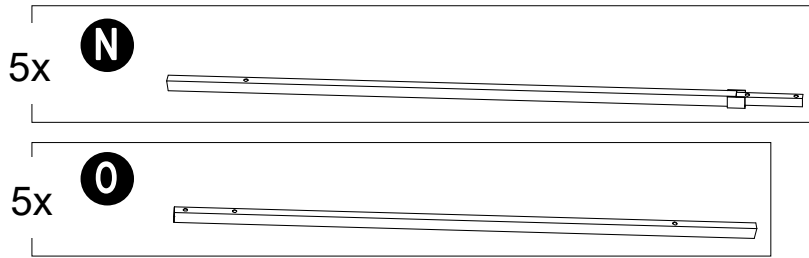

Attach the Middle Small Beam1(N) to the Middle Small Beam2(O) by Bolt(AA), Flat Washer(BB) and Wrench(Z1)

Assembled View:



# STEP 10

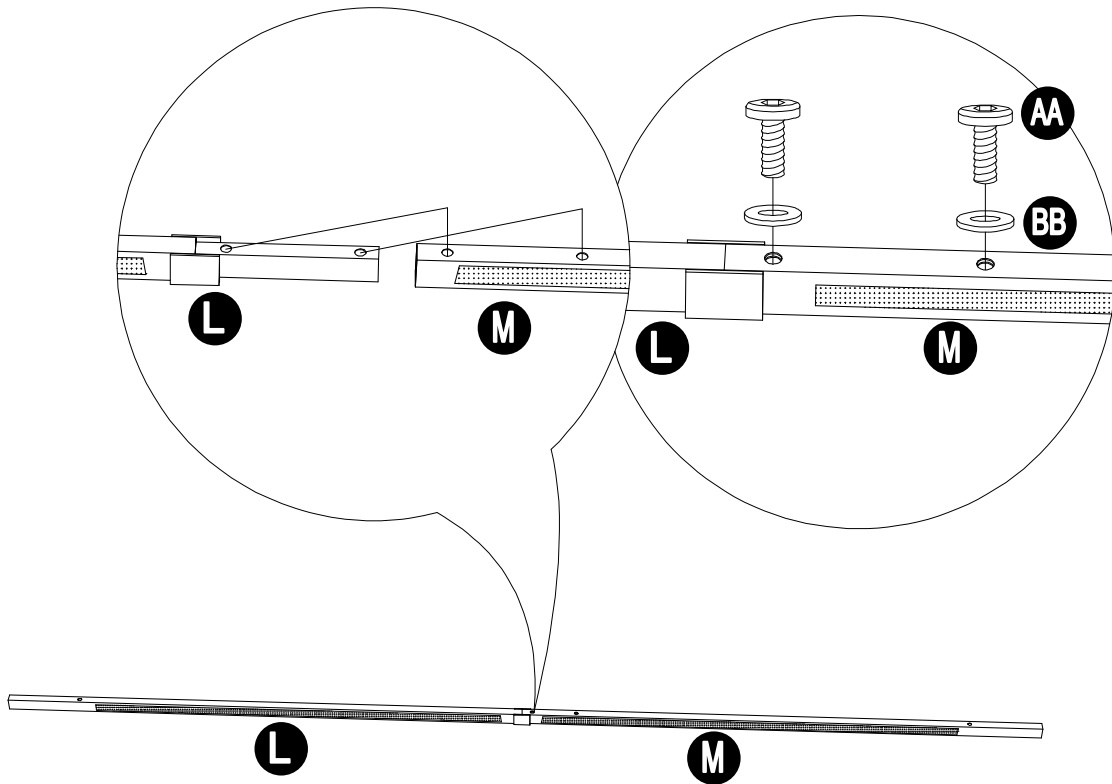
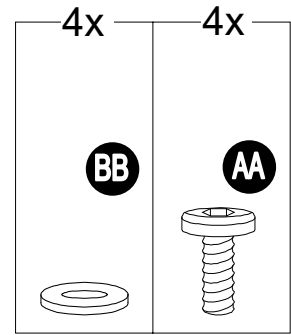
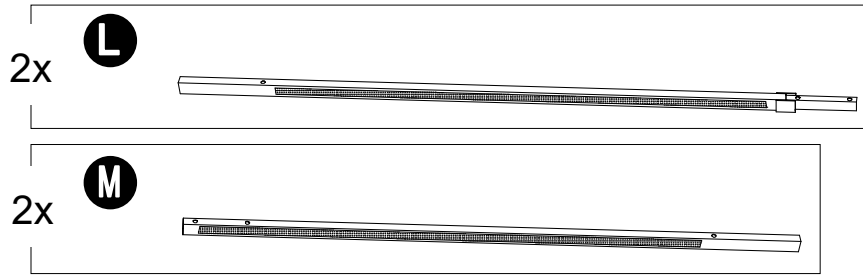

Attach the Side Small Beam1(L) and Side Small Beam2(M) by Bolt(AA), Flat Washer(BB) and Wrench(Z1)

Assembled View:





# STEP 11

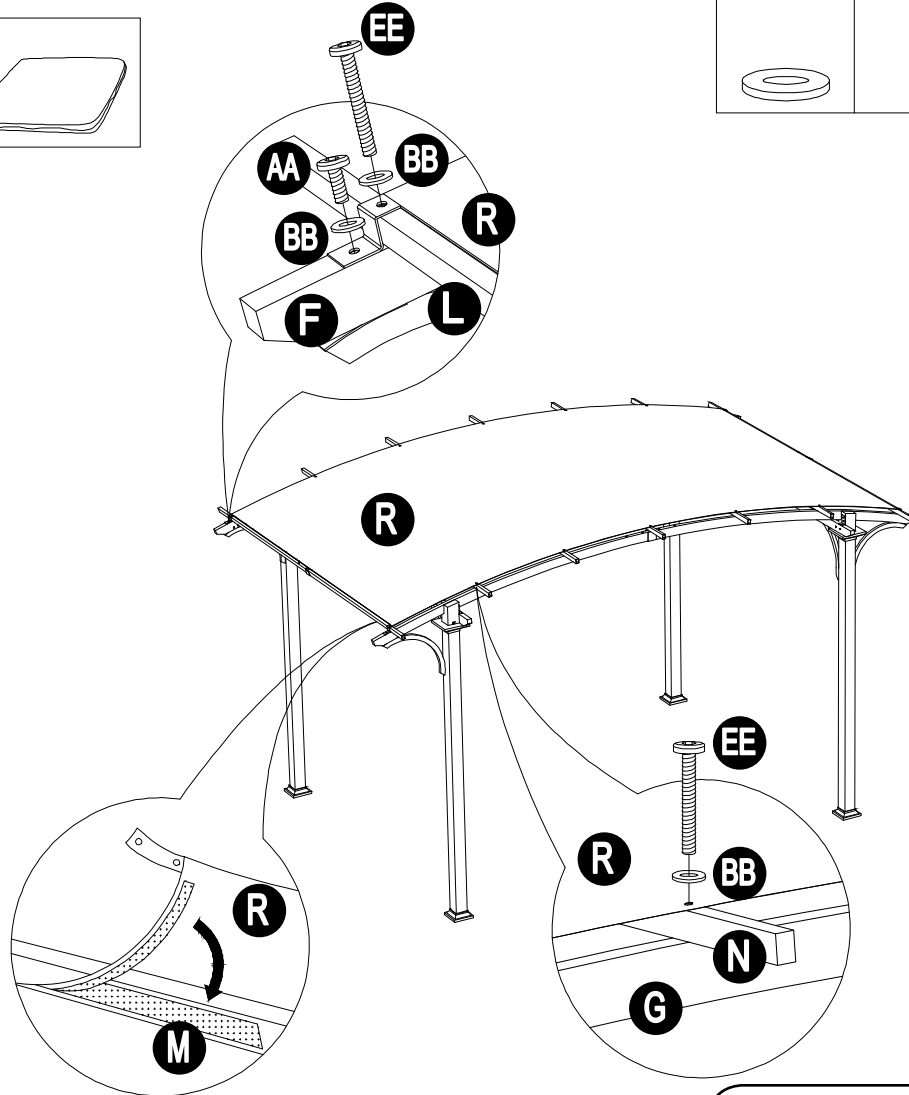
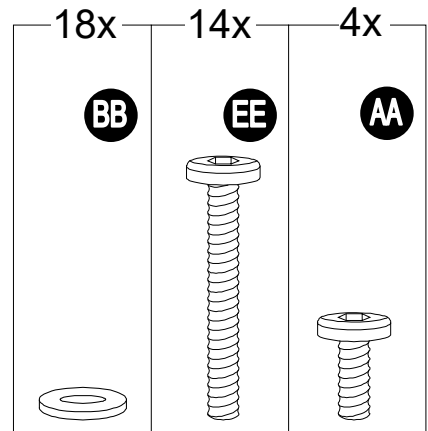
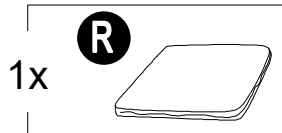
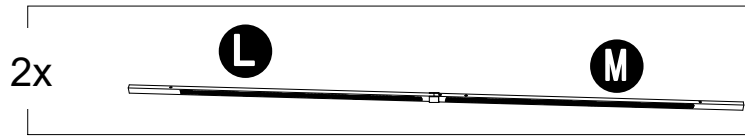
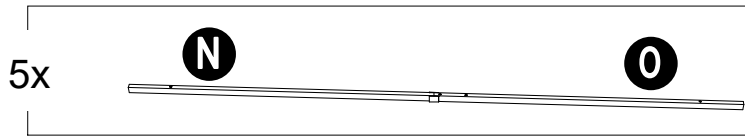

Assembled View:

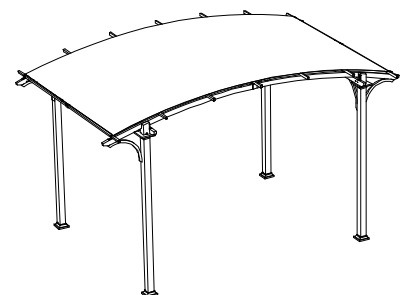

Attach the assembled Beam(N,O,L,M), Canopy and Arc Beam(F,G) by Bolt(AA,EE), Flat Washer(BB) and Wrench(Z1), then stuck the Hoop and Loop.

# STEP 12

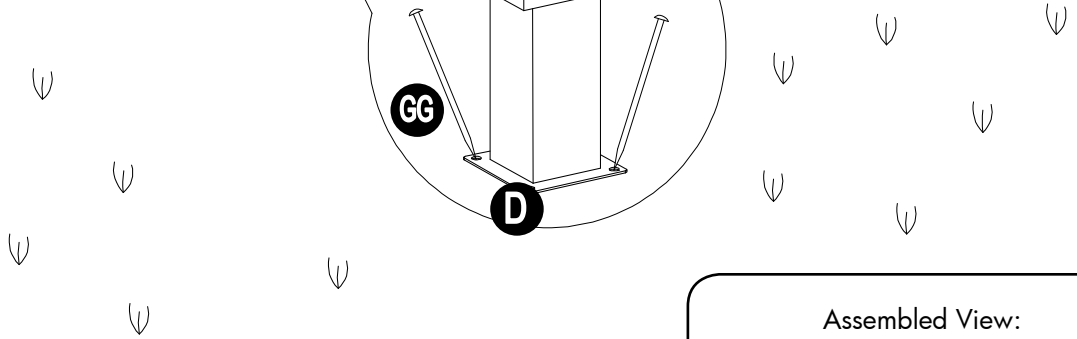
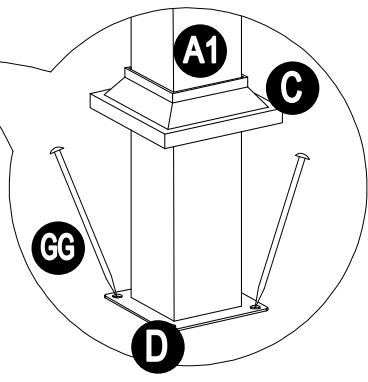
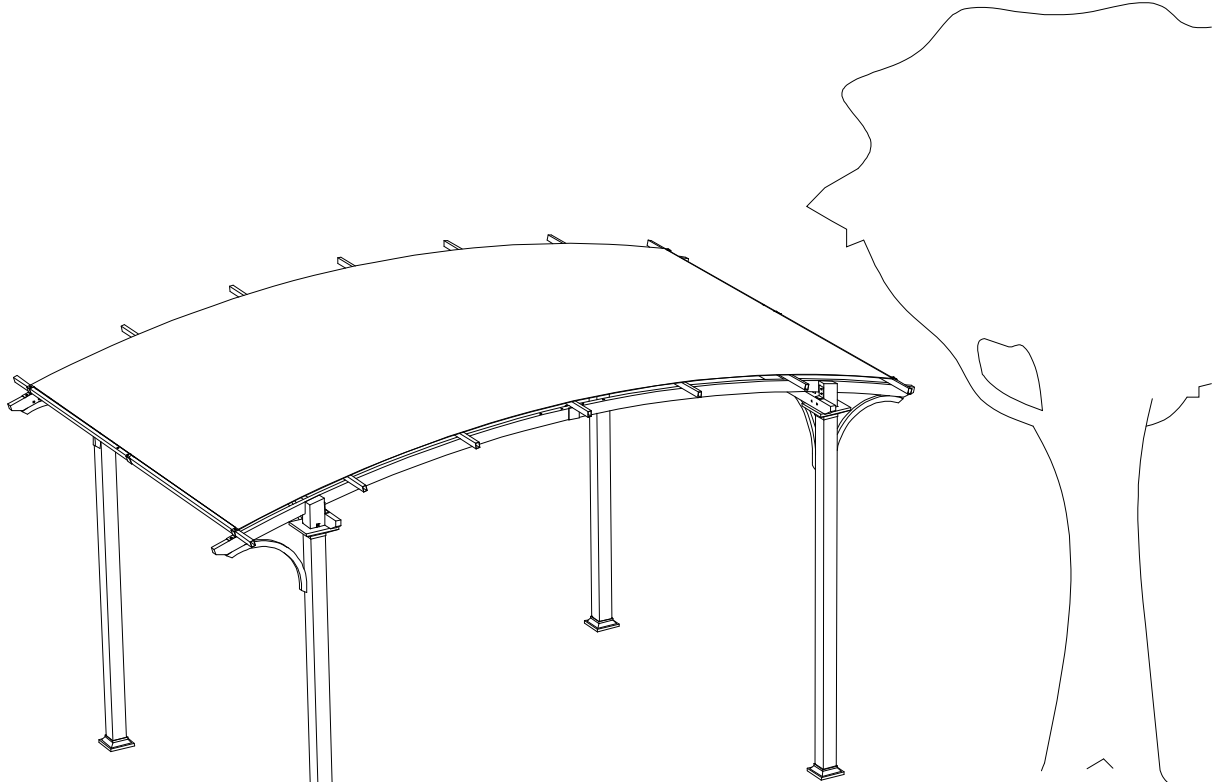
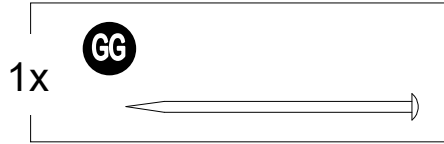

First, pulling the Base Cover(C), then, fix the Netting through Stake(GG) and Base(D) to the ground

