



ASSEMBLY INSTRUCTION

ITEM# : GBO21-305-3

SKU# : 810493160

EASTLAKE COFFEE TABLE

Need help? We are here for you! 1-888-733-8169 Toll Free

Or email us at customerservice_01@yeah.net, customerservice_02@yeah.net

customerservice_03@yeah.net

WARNINGS:

Read all instructions before starting

Clear a flat covered space to being

Always best to do it with a friend

Note that hardware required is provided for every step

Pay attention to orientation

Letter of the part corresponds to a sticker on the products

Number of the hardware corresponds to its letter in the package

Helpful hints provided along the way

WARNINGS:

Use the correct screws as indicated. All screws should be hand tight until the complete piece is assembled (This will make the assembly process much easier). Once the piece is fully assembled, then go back and tight all screws with provided tool.

Keep all children and pets away from assembly area. Children and pets should be supervised when they are in the area of the product construction.

Keep assembly area at least 6 feet from any obstruction such as a fence, garage, house, overhanging branches, laundry line or electrical wires.

Some parts may contain sharp edges. When assembling and using this product, basic safety precautions should always be followed to reduce the risk of personal injury and damage to the product. Please read all instructions before assembly and use.

The table is not to be used for standing purposes and will not function as a stool or step-ladder. Use on even surfaces only.







In order to make the whole product adjust to the best, please install all the screws on the product and tighten all the screws after adjusting the product which can stand on the floor even.

MAINTENANCE:

ALL WEATHER WICKER PRODUCT CARE

Before using, clean the product completely with a soft dry towel. When not in use, wipe free of any dirt or loose objects, wash with a mild solution of soap and water, rinse thoroughly and dry completely. Do not use strong detergent or abrasive cleaners. Over time screws can loosen. Occasionally, check screws on the table, re-tighten if necessary.

PARTS LIST:

Part No.	Part	Qty	Image	Part No.	Part	Qty	Image
1	Table Top	1		4	Screw($\phi 6 \times 15 \text{mm}$)	4	
2	Table Leg	2		5	Screw($\phi 6 \times 25 \text{mm}$)	8	
3	Support	1		6	Washer	12	

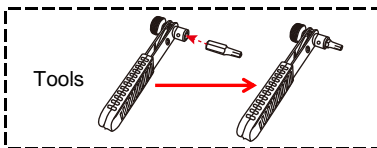

PRODUCT FRAME MAP



STEP 1

PART REQUIRED: 1,2
Keep the screws loose.

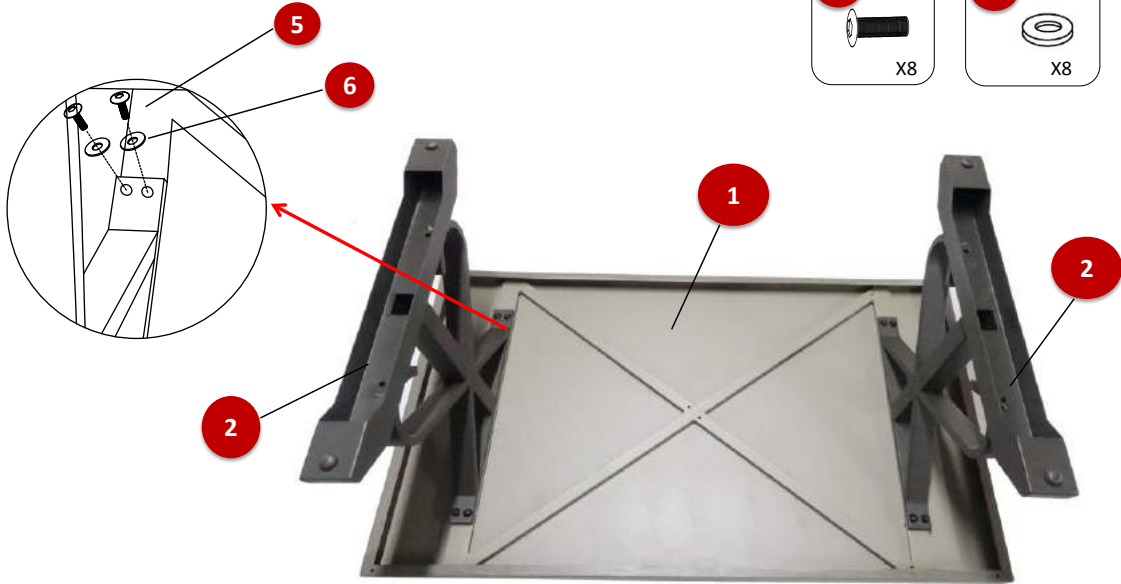

STEP 2

PART REQUIRED: 1, 2 & 3
Keep the screws loose.

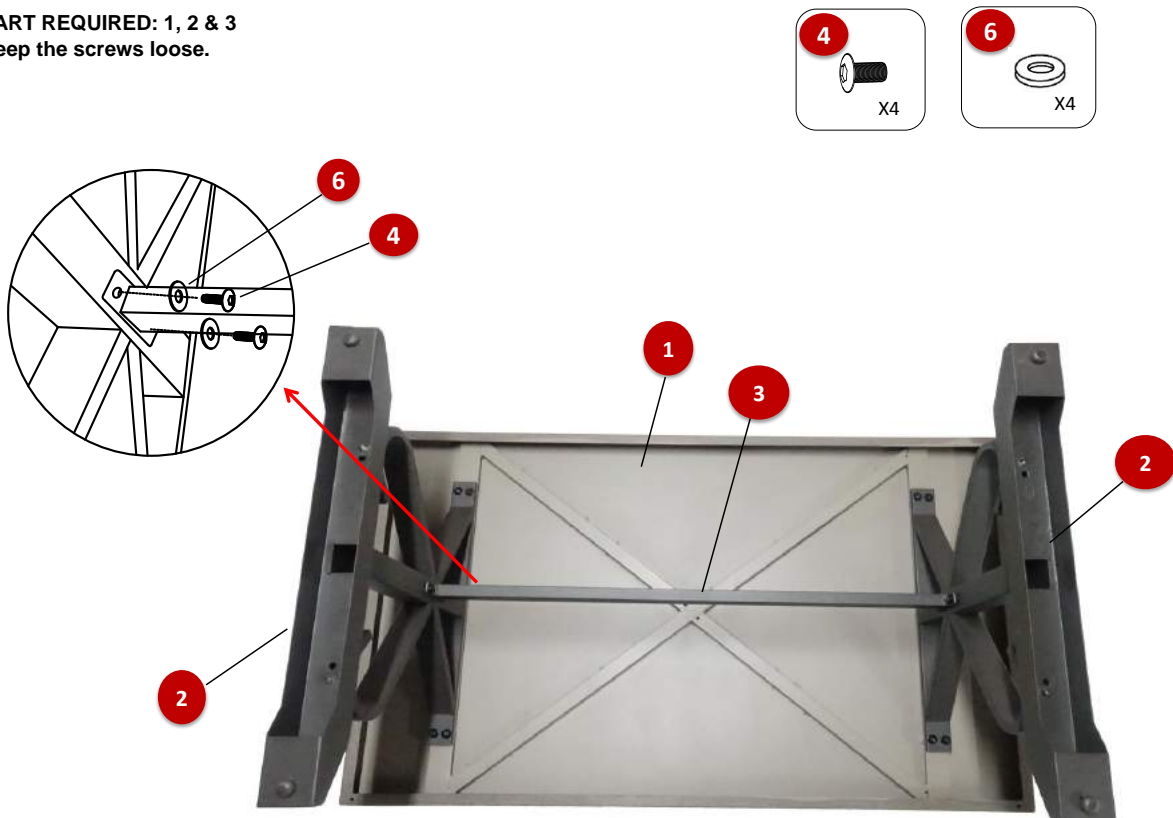

STEP 3

**Tighten all the screws.
Finished!**



Warranty

One-year limited warranty.

Proof of purchase (dated register receipt) is required for warranty claims.

It remains the customer's responsibility for freight and packing charges to and from the service center.