



4PC DK GREY STEEL CONVERSATION SET

ASSEMBLY INSTRUCTION

ITEM# SW-RK967

SKU# 810502909

DO NOT RETURN THIS PRODUCT TO THE STORE. FOR MISSING PARTS OR QUESTIONS TO THIS PRODUCT PLEASE CALL US AT 1-888-733-8169 OR EMAIL US AT customerservice_01@yeah.net OR customerservice_02@yeah.net OR customerservice_03@yeah.net

IMPORTANT:

Please read all the instructions and warnings before assembling. In order to make the whole product adjust to the best, please install all the screws on the product before fully tighten, and note to put the washer to the screw before putting the screw into the screw hole.

WARNING:

Use the correct screws as indicated. All screws should be hand tighten until the complete piece is assembled (This will make the assembly process much easier). Once the piece is fully assembled, then go back and tighten all screws with provided tool.

Keep all children and pets away from assembly area. Children and pets should be supervised when they are in the area of the product construction.

Keep assembly area at least 6 feet from any obstruction such as a fence, garage, house, overhanging branches, laundry line or electrical wires.

Some parts may contain sharp edges. When assembling and using this product, basic safety precautions should always be followed to reduce the risk of personal injury and damage to the product. Please read all instructions before assembly and use.

The sofa is for sitting purpose only, is not to be used for standing purposes and will not function as a stool or step-ladder. Use on even surfaces only.

The chair and sofa are not toys. Sofa tested for use at weight of 350 lb (158.7kg). Chair tested for use at weight of 250 lb (113.6kg). Improper use of this product or failure to use as directed may result in injury. Not intended for commercial use.

CARE & MAINTENANCE

STAIN RESISTANT CUSHIONS CARE — KEEP THE CUSHIONS IN STORAGE IN RAINING DAY.











SPILLS: Immediately wipe up the spill using a white damp cloth. Repeat process if necessary until stain is gone. Allow cushion to air dry.

FABRIC CARE: Hand wash cold, non-chlorine bleach when needed, lay flat to dry. Cool iron if necessary. Do not dry clean.

ALL WEATHER WICKER PRODUCT CARE

Before using, clean the product completely with a soft dry towel. When not in use, wipe free of any dirt or loose objects, wash with a mild solution of soap and water, rinse thoroughly and dry completely. Do not use strong detergent or abrasive cleaners. Screws can be loosen over a period of usage, please check the screws occasionally and re-tighten if necessary.

PARTS LIST FOR SOFA

NO.	Part	Qty	Image	NO.	Part	Qty	Image
A	Sofa Right Arm	1		F	Washer	10	
B	Sofa Left Arm	1		G	Plastic Cover	10	
C	Sofa Seat Panel	1		H	Wrench	1	
D	Sofa Back Panel	1		I	Sofa Seat Cushion	1	
E	Screw	10	 M6*25	J	Sofa Back Cushion	1	

STEP 1

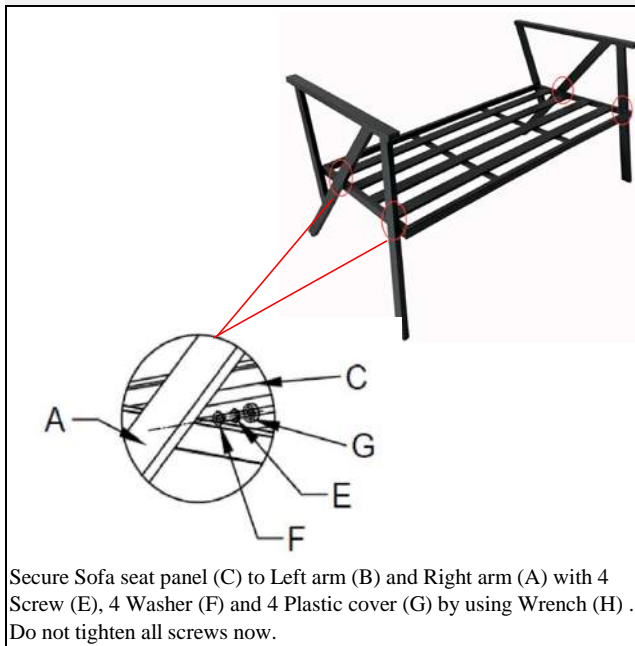

Secure Sofa seat panel (C) to Left arm (B) and Right arm (A) with 4 Screw (E), 4 Washer (F) and 4 Plastic cover (G) by using Wrench (H). Do not tighten all screws now.

STEP 2

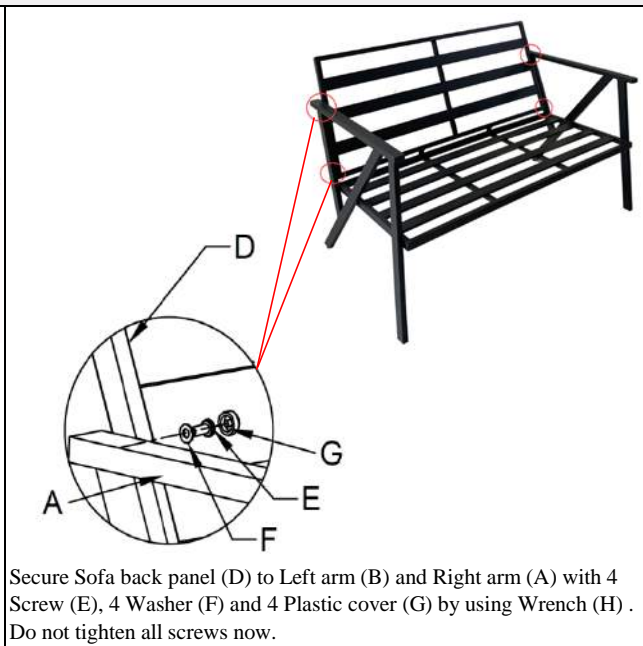

Secure Sofa back panel (D) to Left arm (B) and Right arm (A) with 4 Screw (E), 4 Washer (F) and 4 Plastic cover (G) by using Wrench (H). Do not tighten all screws now.

STEP 3

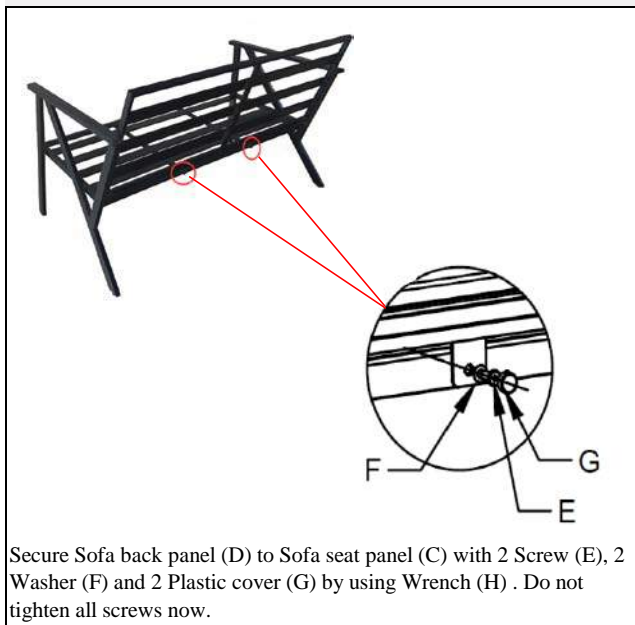





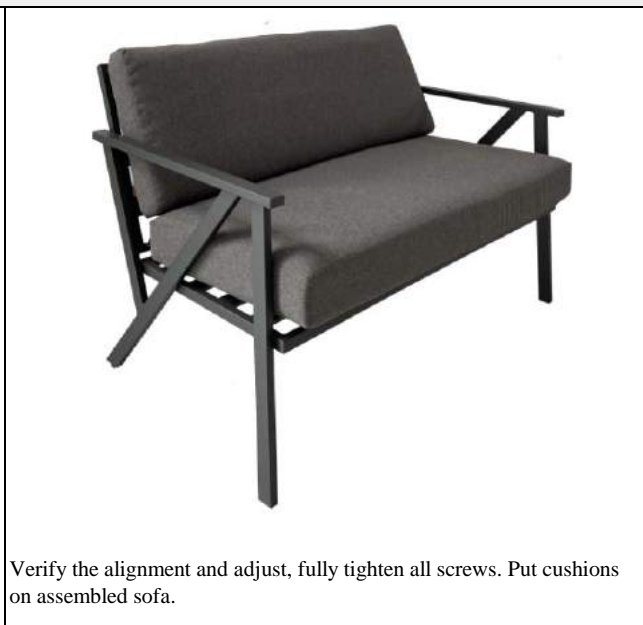





Secure Sofa back panel (D) to Sofa seat panel (C) with 2 Screw (E), 2 Washer (F) and 2 Plastic cover (G) by using Wrench (H). Do not tighten all screws now.

STEP 4



Verify the alignment and adjust, fully tighten all screws. Put cushions on assembled sofa.

PARTS LIST FOR CHAIR

NO.	Part	Qty	Image	NO.	Part	Qty	Image
A	Chair Right Arm	1		F	Washer	8	
B	Chair Left Arm	1		G	Plastic Cover	8	
C	Chair Seat Panel	1		H	Wrench	1	
D	Chair Back Panel	1		I	Chair Seat Cushion	1	
E	Screw	8	 M6*25	J	Chair Back Cushion	1	

STEP 1

STEP 2

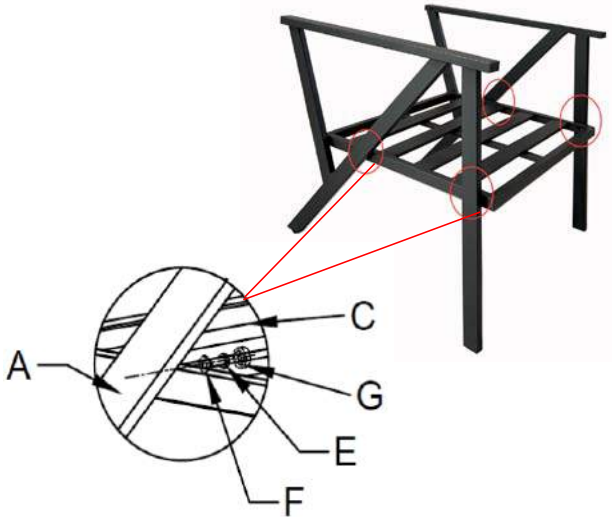

Secure Chair seat panel (C) to Left arm (B) and Right arm (A) with 4 Screw (E), 4 Washer (F) and 4 Plastic cover (G) by using Wrench (H). Do not tighten all screws now.

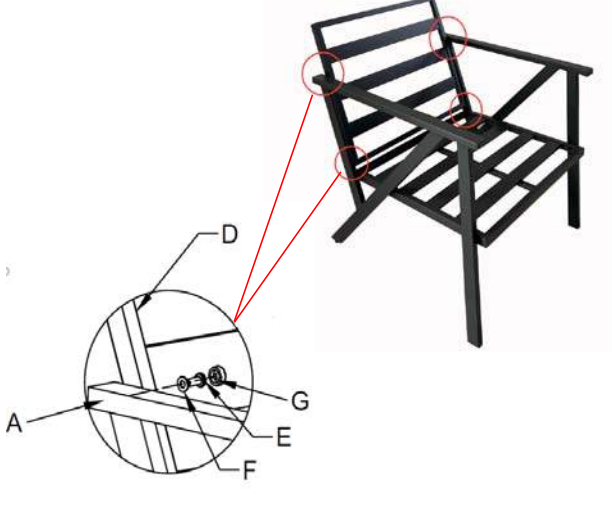







Secure Chair back panel (D) to Left arm (B) and Right arm (A) with 4 Screw (E), 4 Washer (F) and 4 Plastic cover (G) by using Wrench (H). Do not tighten all screws now.

STEP 3



Verify the alignment and adjust, fully tighten all screws. Put cushions on assembled chair.

PARTS LIST FOR TABLE

NO.	Part	Qty	Image	NO.	Part	Qty	Image
A	Table Top	1		F	Washer	8	
B	Table Leg	2		G	Plastic Cover	8	
K	Screw	8	 M6*15	H	Wrench	1	

STEP 1

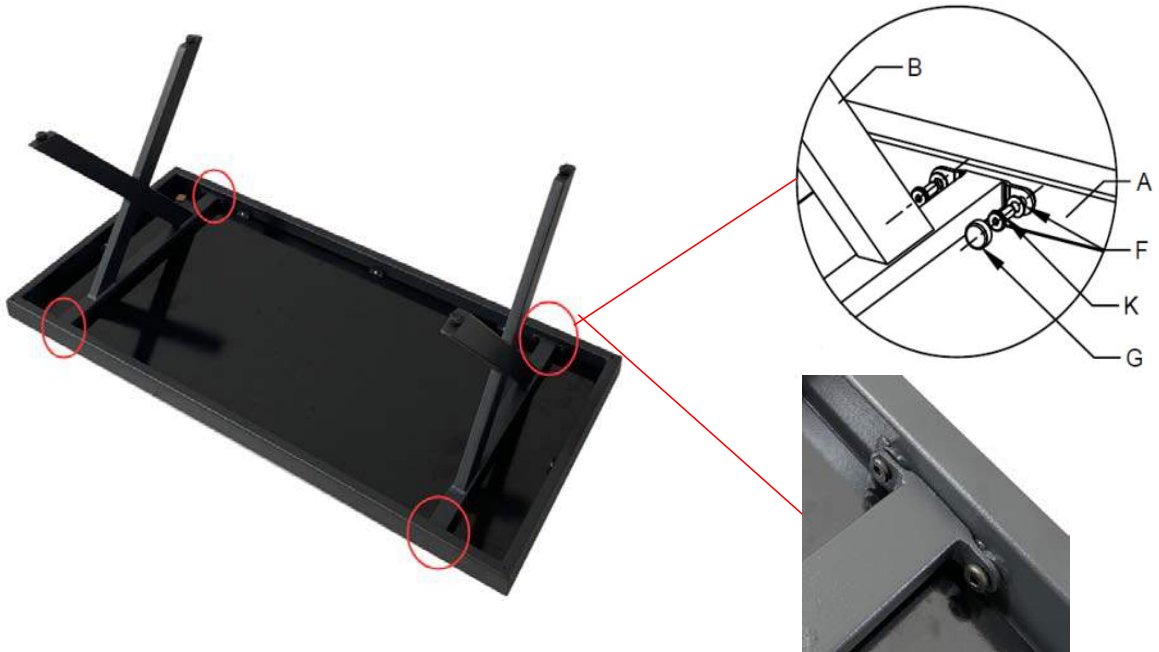

Secure Table top (A) to 2 Table leg (B) with 8 Screw (K), 8 Washer (F) and 8 Plastic cover (G) by using Wrench (H) . Do not tighten all screws now.

STEP 2



Verify the alignment and adjust, fully tighten all screws.