

CHEVAL ESPRESSO MIRROR ARMOIRE

ASSEMBLY INSTRUCTION

ITEM#: BL20201103-2

SKU# 810536905

Need help? We are here for you!
www.biglots.com/help/contact-us

GENERAL BEST PRACTICES FOR ASSEMBLY:

Read all instructions before starting

Clear a flat covered space to begin

We recommend 2 people for assembly

Note that hardware required is provided for every step

Pay attention to orientation

Letter of the part corresponds to a sticker on the product

Number of the hardware corresponds to its number in the package

Helpful hints provided along the way

MAINTENANCE:

Check bolts/screws periodically and tighten if necessary.

WARNING: Should this produce become damaged, and/or components are broken or missing, DO NOT USE.

CARE AND CLEANING:

DO NOT scratch or chip the finish.

DO NOT use abrasive chemicals for cleaning.

Clean with mild soap on a soft rag.

Rinse and dry thoroughly.

WARNINGS:

SUGGEST 2 ADULTS TO ASSEMBLE THIS PRODUCT IN AN OPEN AREA.



DO NOT USE POWER TOOLS TO ASSEMBLE.

TO PREVENT SERIOUS INJURY OR DEATH, THIS PRODUCT IS EQUIPPED WITH A WALL ANCHORING SYSTEM. BEFORE THIS PRODUCT CAN BE USED, THE WALL ANCHORING SYSTEM MUST BE INSTALLED AS DIRECTED IN THE ASSEMBLY INSTRUCTIONS.

PARTS LIST

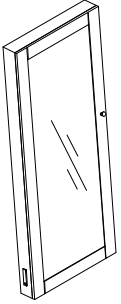

A

x1pc
MIRROR



B

x2PCS
DRESSING MIRROR FOOT

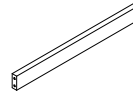

C

x1PC
CONNECTED WOOD

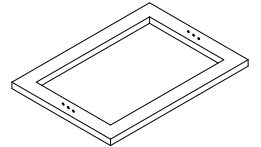

D

x1PC
MIRROR

HARDWARE LIST

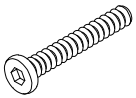

1

x6pcs
Screw



2

x2pcs
Screw



3

x2pcs
Gasket

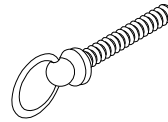

4

x2pcs
Screw

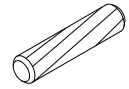

5

x4pcs
Wooden dowel

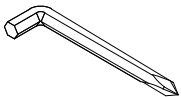

6

x1pc
Wrench



7

x1pc
Screw



8

x1pc
Handle

STEP 1

(B) and (C) connect each other, needs (1, 6, 5) screws, wrench, wooden dowel.

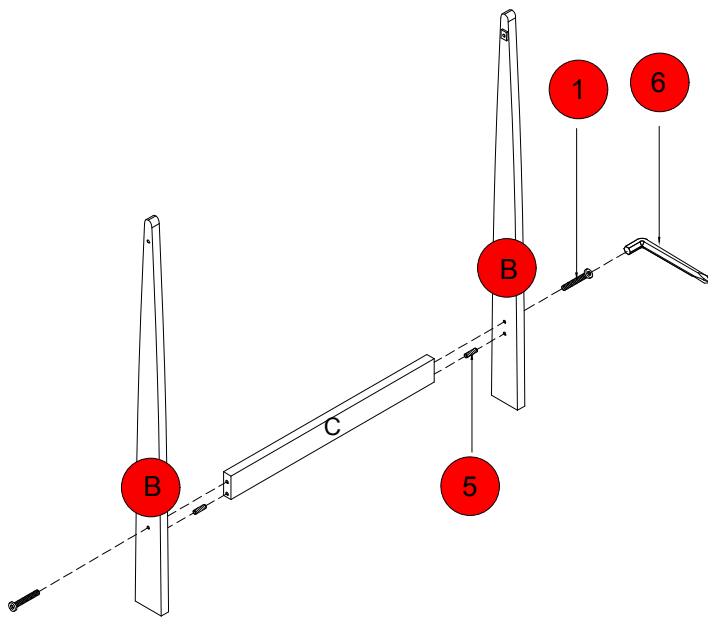
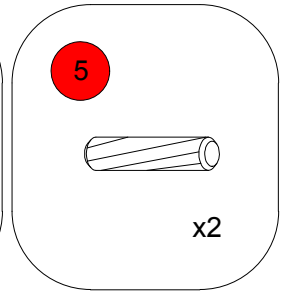
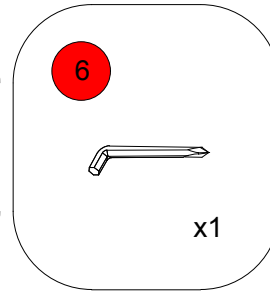
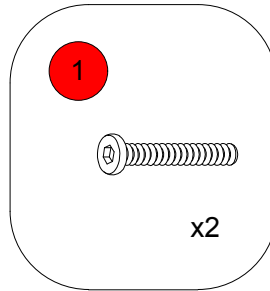

Assembled View

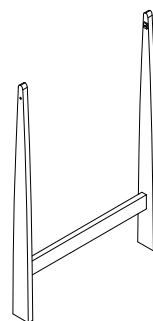

STEP 2

(B) Dressing Mirror Foot and (D) mirror base connect each other, must installed (5) wooden dowels. Then, it locked with (1) screws.

1



x4

6



x1

5



x2

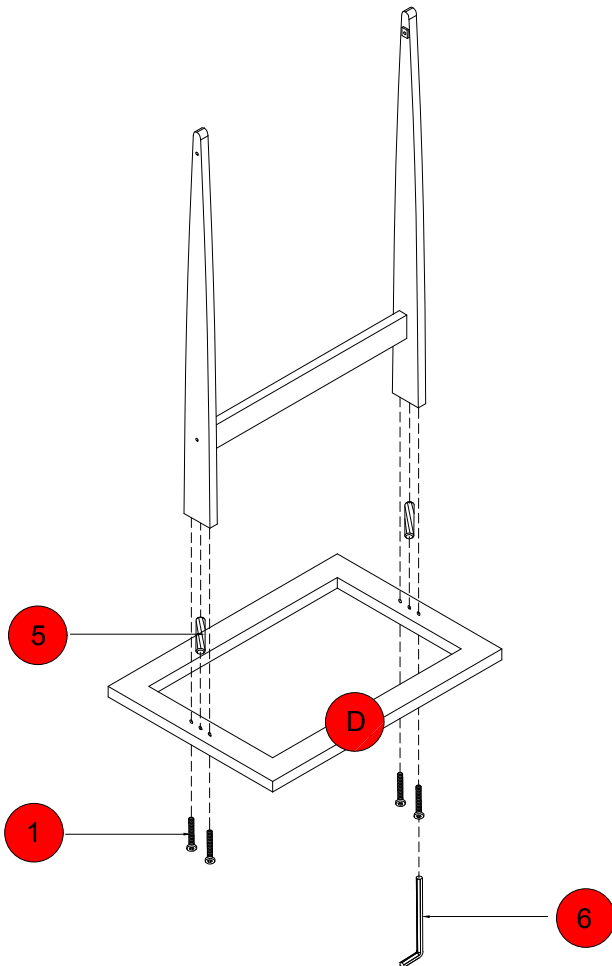

Assembled View

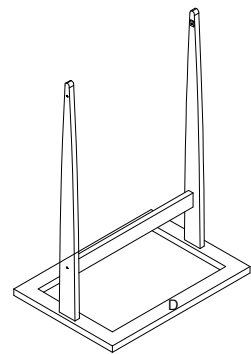

STEP 3

(A) which is the Main body (mirror) must be fastening with (4, 6, 3) screws, wrench and gaskets on both sides.

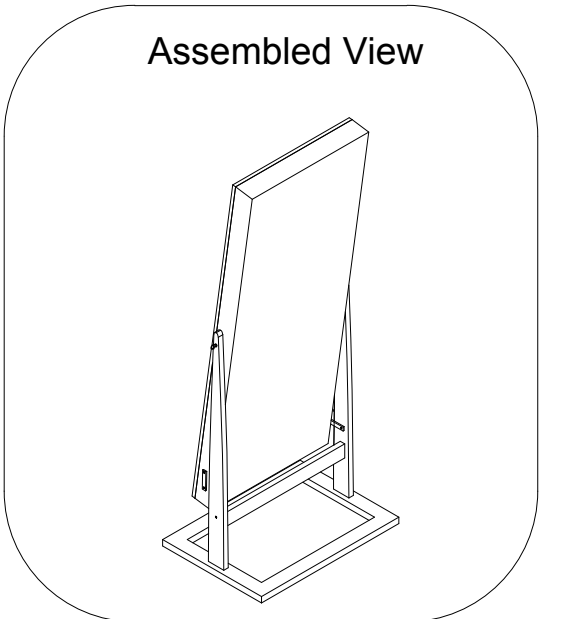
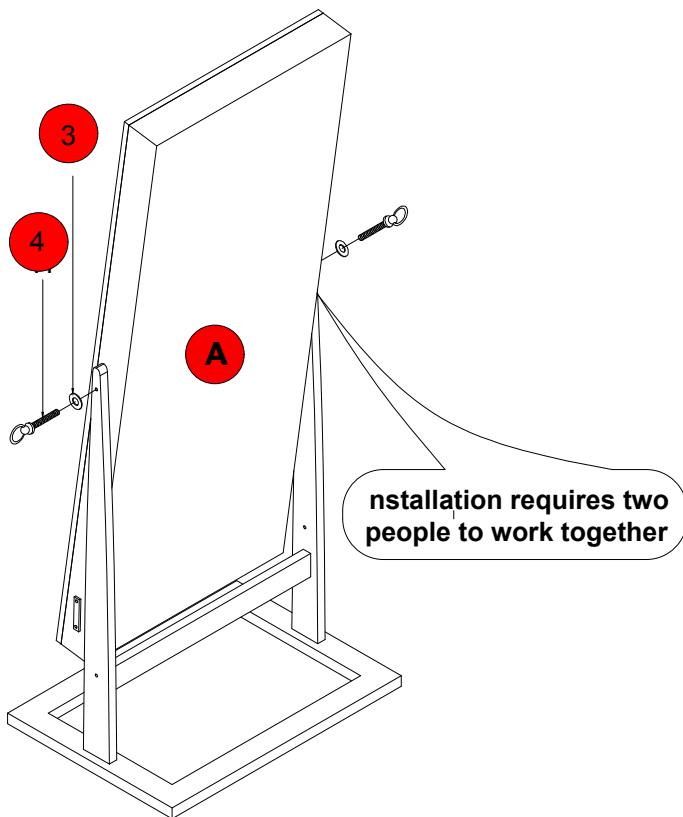
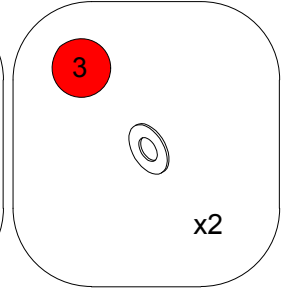
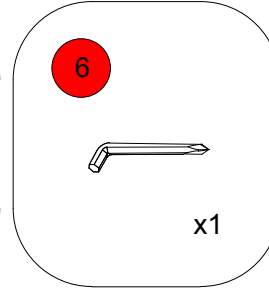
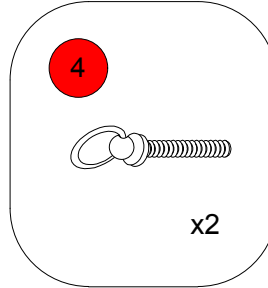

STEP 4

(A) Which is the main body (mirror) and (B) dressing mirror foot connect each other, needs two people to do assembly.

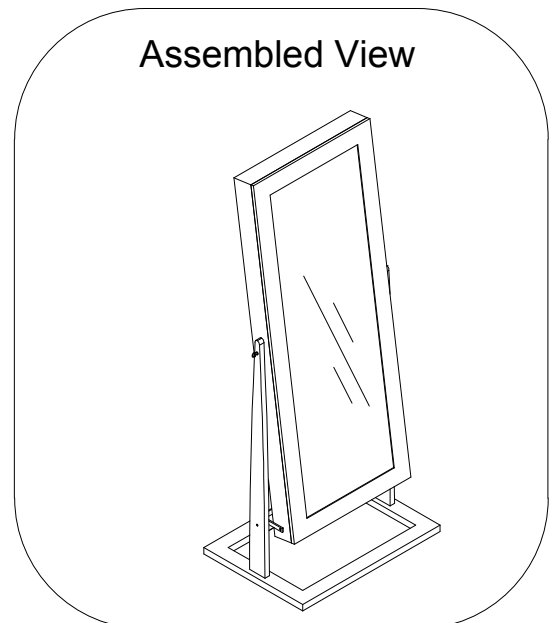
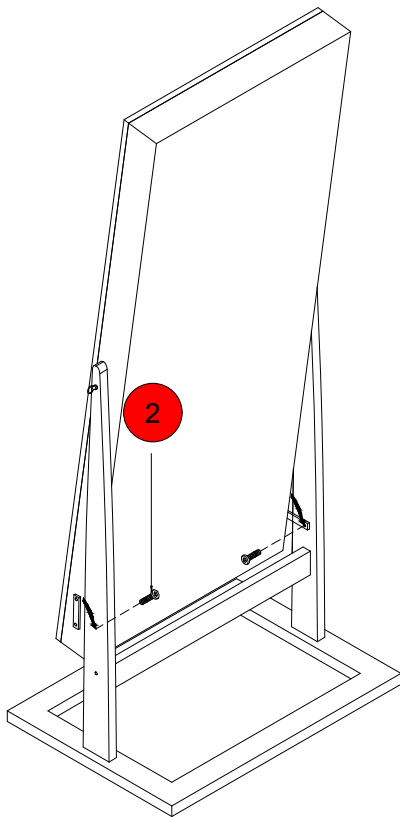
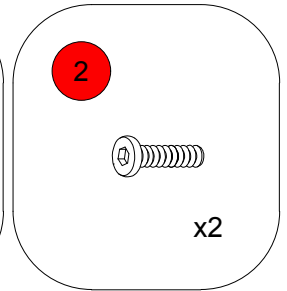
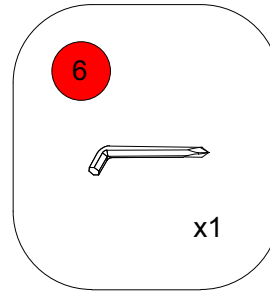

STEP 5

Assembly and installed them with (7) screw and (8) handles.

