



## **ASSEMBLY INSTRUCTION**

ITEM#: H21GS155VS

SKU#: 810544444

---

# **SANDPOINTE 5PC SECTIONAL SET**

---

Need help? We are here for you!

1 (877) 800 – 6021

• Toll Free

[service@hccipatio.com](mailto:service@hccipatio.com) • Email Address

---

---

# GENERAL BEST PRACTICES FOR ASSEMBLY:

---

---

To Ensure Alignment & Easy Assembly, Secure All Bolts & Washers In Place Before Fully Tightening

Read all instructions before starting

Clear a flat covered space to begin assembly

Always best to do it with a friend

Note that hardware required is provided for every step

Pay attention to orientation

Letter of the part corresponds to a sticker on the product

Number of the hardware corresponds to its letter in the package

Helpful hints provided along the way

Retain these assembly instructions for future reference.

---

---

## WARNINGS:

---

---

Regularly check hardware and tighten if necessary

Use the correct bolts as indicated. Do not tighten any of the bolts until the chair is completely assembled.

Use the correct bolts as indicated. Do not tighten any of the bolts until the table is completely assembled.

Do not discard any of the packaging until you have checked that you have all of the parts and fittings required.

Do not sit or stand on this table. Misuse of the table may result in damage or injury.

Keep children away during assembly. This item contains small parts that can be swallowed by children.

Children should always be under direct adult supervision while using this product.

Sofa is for sitting purposes only. Standing on or misuse of sofa may result in damage or injury. Not intended for commercial use. Weight limit for one sofa is 750 lbs (340.5 kg).

Do not sit or stand on table. Misuse of table may result in damage or injury. Not intended for commercial use.

Ottomans are for sitting purposes only. Standing on or misuse of ottomans may result in damage or injury.

Not intended for commercial use. Weight limit is 250 lbs (113.5 kg).

---

---

## MAINTENANCE:

---

---

Wash frame, wicker and fabric parts with mild soap and water, rinse thoroughly, and dry completely. Do not use bleach, acid, or other solvents on the frame, wicker or fabric parts.

The cushions may be washed on the surface only by using mild soap and water or a commercial foaming upholstery cleaner if necessary. If washed, rinse well and hang to dry. Do not machine wash or dry.

We recommend the use of furniture covers when not in use.







Inspect and tighten all of the bolts and fasteners on a regular basis to ensure the proper performance and safety of your chair, table and ottoman.





When moving the table, lift. Do not drag this table.

In order to prolong the life and beauty of your chair, table and ottoman we recommend that it be stored in a dry and protected area during off season periods.

# H21GK018VZ

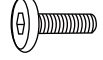
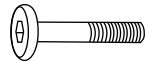
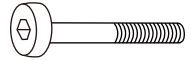
## PARTS LIST

PART NO.	MATERIAL CODE	PART	Q'TY
1	H21GK018VZ-BG	 BACK ASSEMBLY	1
2	H21GK018VZ-ZG	 SEAT ASSEMBLY	1
3	H21GK018VZ-ZSB	 LEFT ARM	1
4	H21GK018VZ-ZZG	 LEG	1
5	H21GK018VZ-JZG	 SUPPORT	1
6	H21GK018VZ-JD	 LEG CAP	4

7	LS-M6-15	 BOLT M6*15	6
8	LS-M6-50	 BOLT M6*50	9
9	PTLS-M8-100	 BOLT M8*100	4
10	DP-d6.5-D13	 WASHER d6.5*D13*1.0	24
11	LM-M6	 JAM NUT M6*1.0	9
12	H21GK018VZ-BM	 BACK CUSHION	3
13	H21GK018VZ-ZM	 SEAT CUSHION	3

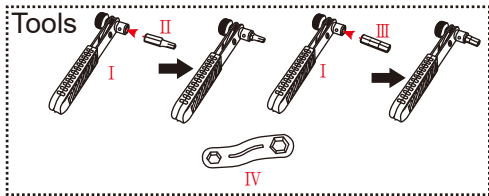

# STEP 1

PARTS REQUIRED: 1, 2, 8, 10, & 11  
Keep the bolts loose.

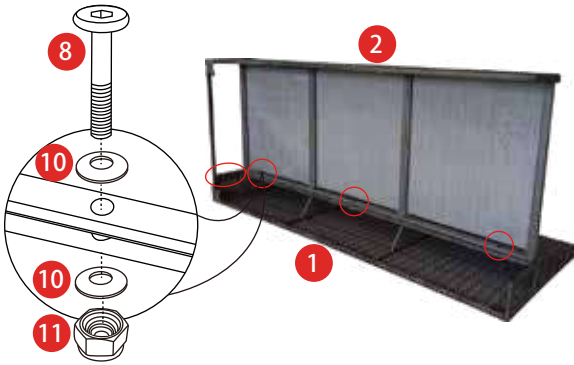
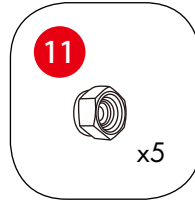
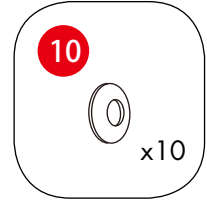
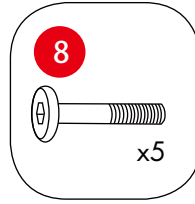

# STEP 2

PARTS REQUIRED: 1, 2, 3, 8, 10, & 11  
Tighten all bolts by using the supplied Hex key.

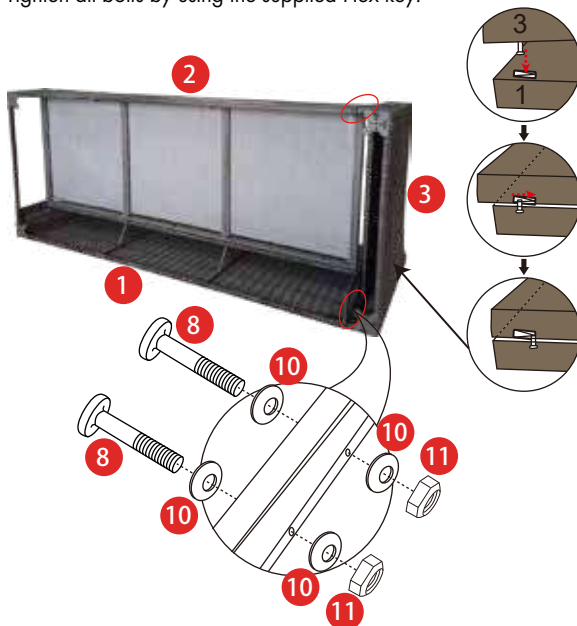
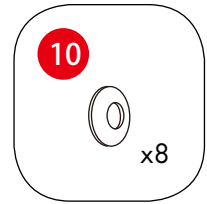
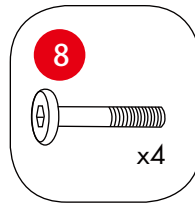

---

---

## STEP 3

---

---

PARTS REQUIRED: 1, 2, 4, 7, & 10

Tighten all bolts by using the supplied Hex key.

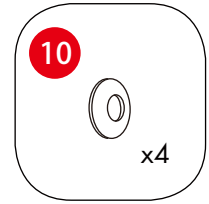
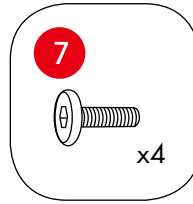
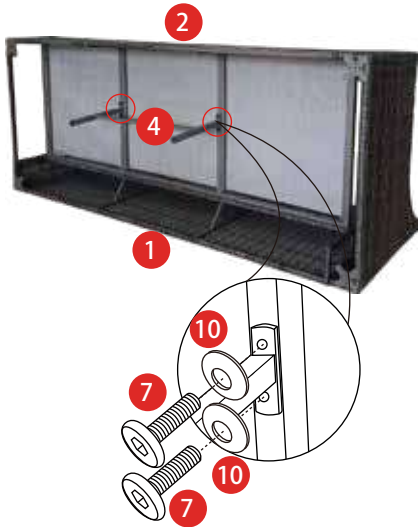

---

---

## STEP 4

---

---

PARTS REQUIRED: 1, 2, 5, 7, & 10

Tighten all bolts by using the supplied Hex key.

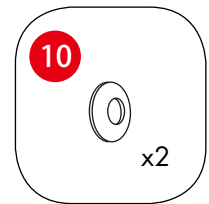
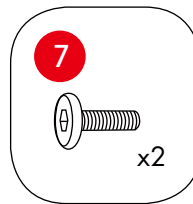
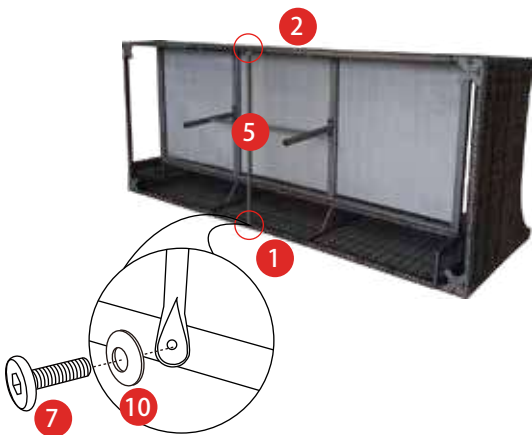

---

---

## STEP 5

---

---

PARTS REQUIRED: 1, 2, 3, 6, & 9

Tighten all bolts by using the supplied Hex key.

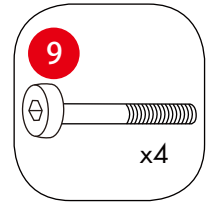
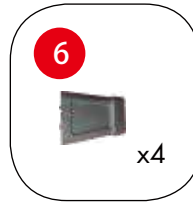
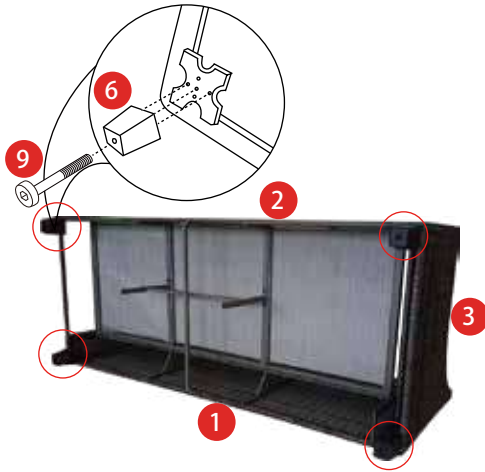

---

---

## STEP 6

---





---





PARTS REQUIRED: 12 & 13

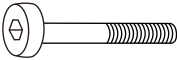

# H21GK018VN

## PARTS LIST

PART NO.	MATERIAL CODE	PART	Q'TY
1	H21GK018VN-YJ	 CHAIR ASSEMBLY	1
2	H21GK018VN-JZG	 LEG	1
3	H21GK018VN-JD	 LEG CAP	4
4	LS-M6-15	 BOLT M6*15	4
5	PTLS-M8-100	 BOLT M8*100	4

PART NO.	MATERIAL CODE	PART	Q'TY
6	DP-d6.5-D13	 WASHER d6.5*D13*1.0	4
7	H21GK018VN-ZBM	 LEFT BACK CUSHION	1
8	H21GK018VN-YBM	 RIGHT BACK CUSHION	1
9	H21GK018VN-BM	 BACK CUSHION	2
10	H21GK018VN-ZM	 SEAT CUSHION	3

## STEP 1

PARTS REQUIRED: 1, 2, 3, 4, 5, & 6

Tighten all bolts by using the supplied Hex key.

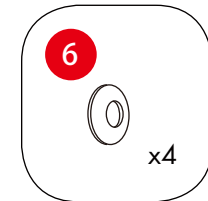
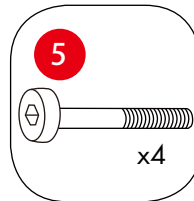
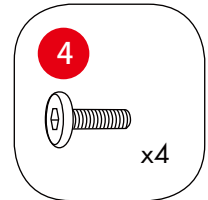
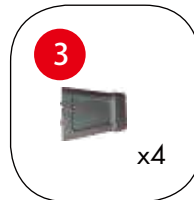
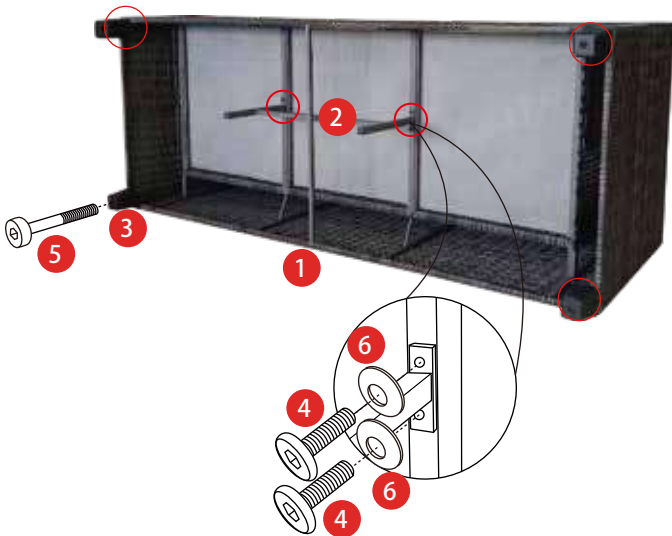

---

---

## STEP 2

---

---

PARTS REQUIRED: 7, 8, 9, & 10







# H21GT759MD

## PARTS LIST

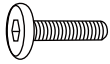
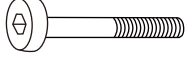
PART NO.	MATERIAL CODE	PART	Q'TY
1	H21GT759MD-ZM	 TABLE TOP	1
2	H21GT759MD-JA	 LEG A	1
3	H21GT759MD-JB	 LEG B	1

4	H21GT759MD-JD	 PLASTIC LEG CAP	4
5	LS-M6-15	 BOLT M6*15	8
6	PTLS-M8-100	 BOLT M8*100	4
7	DP-d6.5-D13	 WASHER d6.5*D13*1.0	8

## STEP 1

PARTS REQUIRED: 2, 3, 4, & 6

Tighten all bolts by using the supplied Hex key.

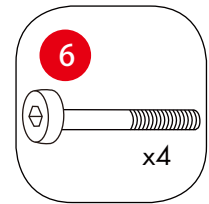
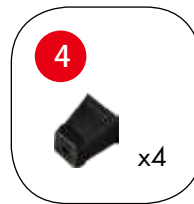
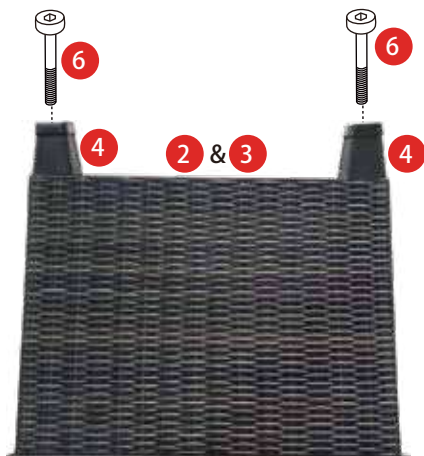

---

---

## STEP 2

---

---

PARTS REQUIRED: 1, 2, 3, 5 & 7

Tighten all bolts by using the supplied Hex key.

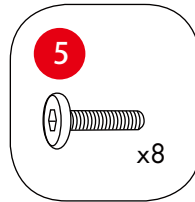
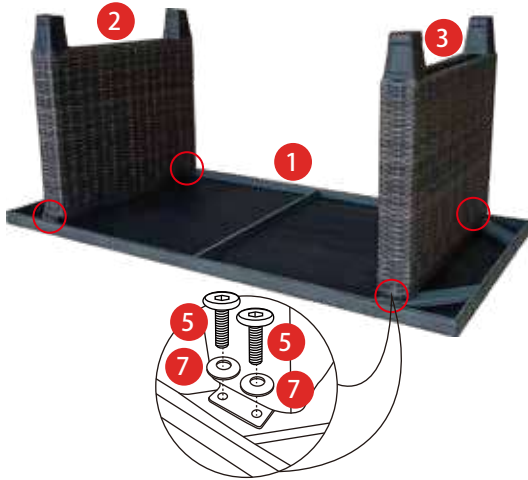

---

---

## STEP 3



---



---



# H21GX903VO

## PARTS LIST

PART NO.	MATERIAL CODE	PART	Q'TY
1	H21GX903VO-JK	 SEAT ASSEMBLY	1
2	PTLS-M8-100	 BOLT M8*100	4

PART NO.	MATERIAL CODE	PART	Q'TY
3	H21GX903VO-JD	 PLASTIC LEG CAP	4
4	H21GX903VO-MD	 CUSHION	1

---

## STEP 1

---

PARTS REQUIRED: 1, 2, & 3

Tighten all bolts by using the supplied Hex key.

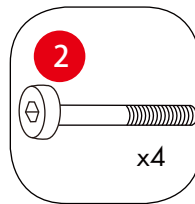
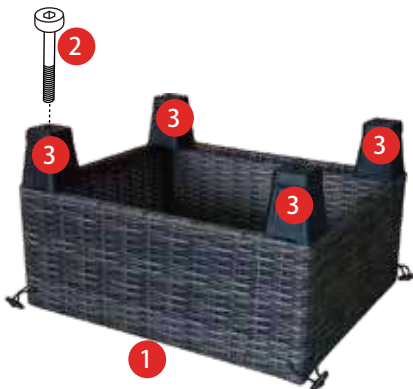

## STEP 2

PARTS REQUIRED: 4

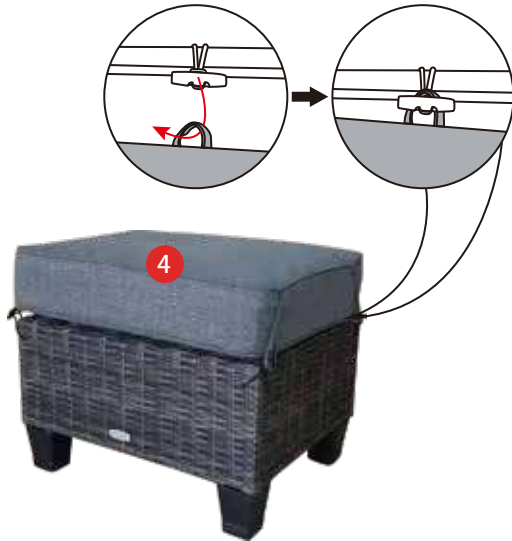

### Warranty

- One-year limited warranty.
- Proof of purchase (dated register receipt) is required for warranty claims.
- It remains the customer's responsibility for freight and packing charges to and from the service center.

## Securing Clips

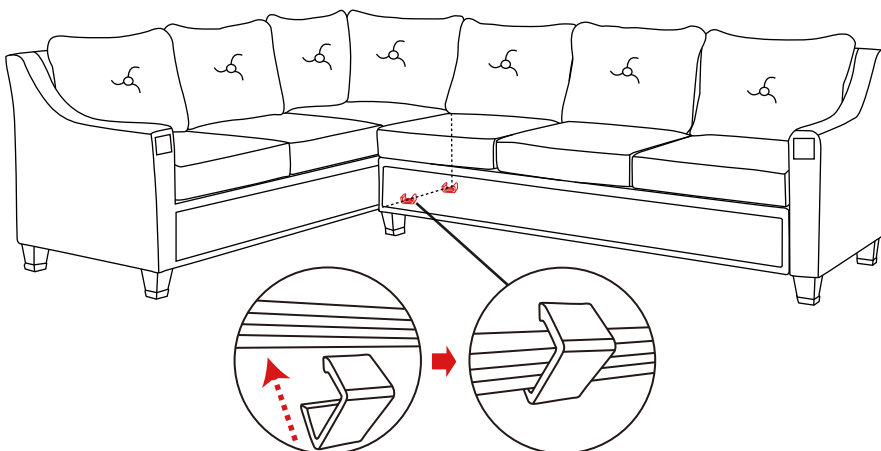

Please use the clips to connect and secure each section together. Use of the clips is optional and dependent upon the user's personal preference.

# STOP!

## Missing A Part? No Need To Go Back To The Store

The store where you made your purchase does not stock parts for this item.  
If you need parts, whether they are missing or damaged,

Call Toll Free:

TEL: 1-877-800-6021

Call us between 9:00 AM and 4:30 PM Eastern Time Monday through Friday  
For further assistance, please visit us at [service@hicipatio.com](mailto:service@hicipatio.com)