



ASSEMBLY INSTRUCTION

ITEM#: H21GS193VB

SKU#: 810554591

**SANDPOINTE 3PC
ROCKER & TABLE SET**

Need help? We are here for you!

1 (877) 800 – 6021

• Toll Free

service@hccipatio.com • Email Address

GENERAL BEST PRACTICES FOR ASSEMBLY:

To Ensure Alignment & Easy Assembly, Secure All Bolts & Washers In Place Before Fully Tightening

Read all instructions before starting

Clear a flat covered space to begin assembly

Always best to do it with a friend

Note that hardware required is provided for every step

Pay attention to orientation

Letter of the part corresponds to a sticker on the product

Number of the hardware corresponds to its letter in the package

Helpful hints provided along the way

Retain these assembly instructions for future reference.

WARNINGS:

Regularly check hardware and tighten if necessary

Use the correct bolts as indicated. Do not tighten any of the bolts until the chair is completely assembled.

Use the correct bolts as indicated. Do not tighten any of the bolts until the table is completely assembled.

Do not discard any of the packaging until you have checked that you have all of the parts and fittings required.

Do not sit or stand on this table. Misuse of the table may result in damage or injury.

Keep children away during assembly. This item contains small parts that can be swallowed by children. Children should always be under direct adult supervision while using this product.

Chairs are for sitting purposes only. Standing on or misuse of chair may result in damage or injury. Not intended for commercial use. Weight limit is 250 lbs (113 kg).

Do not sit or stand on table. Misuse of table may result in damage or injury. Not intended for commercial use.

MAINTENANCE:

Wash frame, wicker and fabric parts with mild soap and water, rinse thoroughly, and dry completely. Do not use bleach, acid, or other solvents on the frame, wicker or fabric parts.

The cushions may be washed on the surface only by using mild soap and water or a commercial foaming upholstery cleaner if necessary. If washed, rinse well and hang to dry. Do not machine wash or dry.

We recommend the use of furniture covers when not in use.



Inspect and tighten all of the bolts and fasteners on a regular basis to ensure the proper performance and safety of your chair, table and ottoman.





When moving the table, lift. Do not drag this table.

In order to prolong the life and beauty of your chair, table and ottoman we recommend that it be stored in a dry and protected area during off season periods.

H21GR063VR

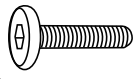
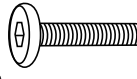
PARTS LIST

| PART NO. | MATERIAL CODE | PART | Q'TY |
|----------|----------------|--|------|
| 1 | H21GR063VR-BG |  BACK ASSEMBLY | 1 |
| 2 | H21GR063VR-ZG |  SEAT ASSEMBLY | 1 |
| 3 | H21GR063VR-ZSB |  LEFT ARM | 1 |
| 4 | H21GR063VR-YSB |  RIGHT ARM | 1 |
| 5 | LS-M6-15 |  BOLT M6*15 | 4 |

| PART NO. | MATERIAL CODE | PART | Q'TY |
|----------|---------------|--|------|
| 6 | LS-M6-30 |  BOLT M6*30 | 4 |
| 7 | LS-M6-40 |  BOLT M6*40 | 2 |
| 8 | DP-d6.5-D13 |  WASHER d6.5*D13*1.0 | 10 |
| 9 | H21GR063VR-BM |  BACK CUSHION | 1 |
| 10 | H21GR063VR-ZM |  SEAT CUSHION | 1 |

Tools

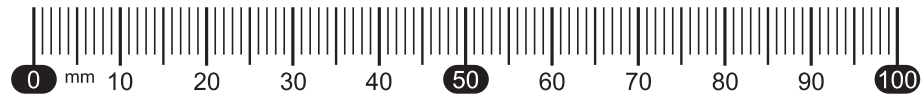

STEP 1

PARTS REQUIRED: 2, 3, 4, 6, & 8
Keep the bolts loose.

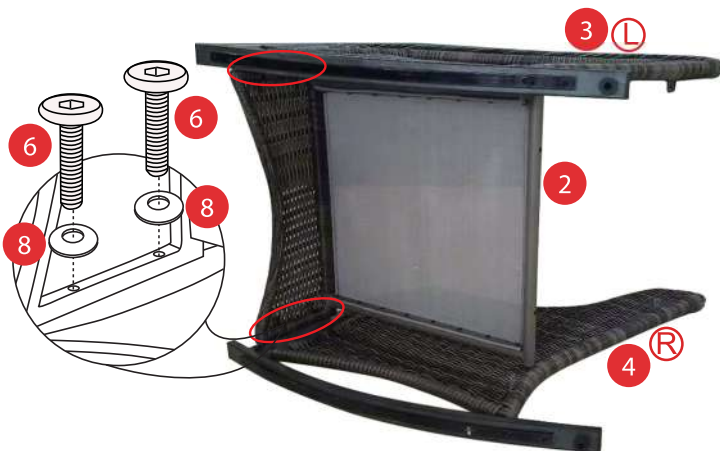
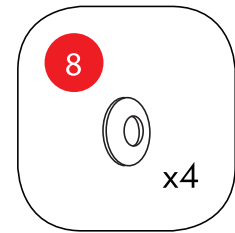
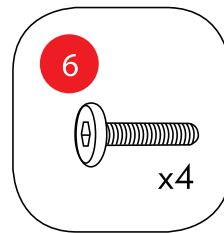

Note:

The labels marked "L" and "R" on arms (#3 and #4) should coincide with Figure 1 to ensure proper assembly.

STEP 2

PARTS REQUIRED: 1, 2, 3, 4, 5, 7, & 8
Keep the bolts loose.

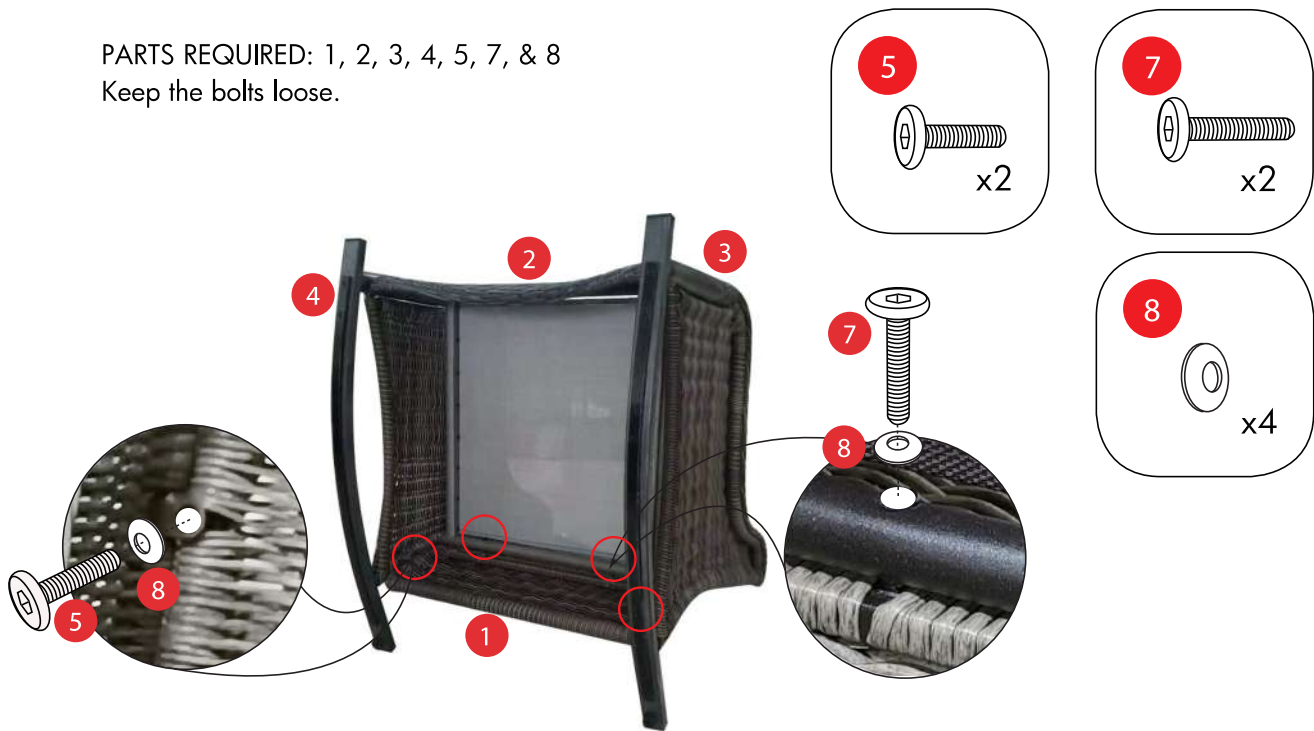

STEP 3

PARTS REQUIRED: 1, 3, 4, 5, & 8
Tighten all bolts by using the supplied Hex key.

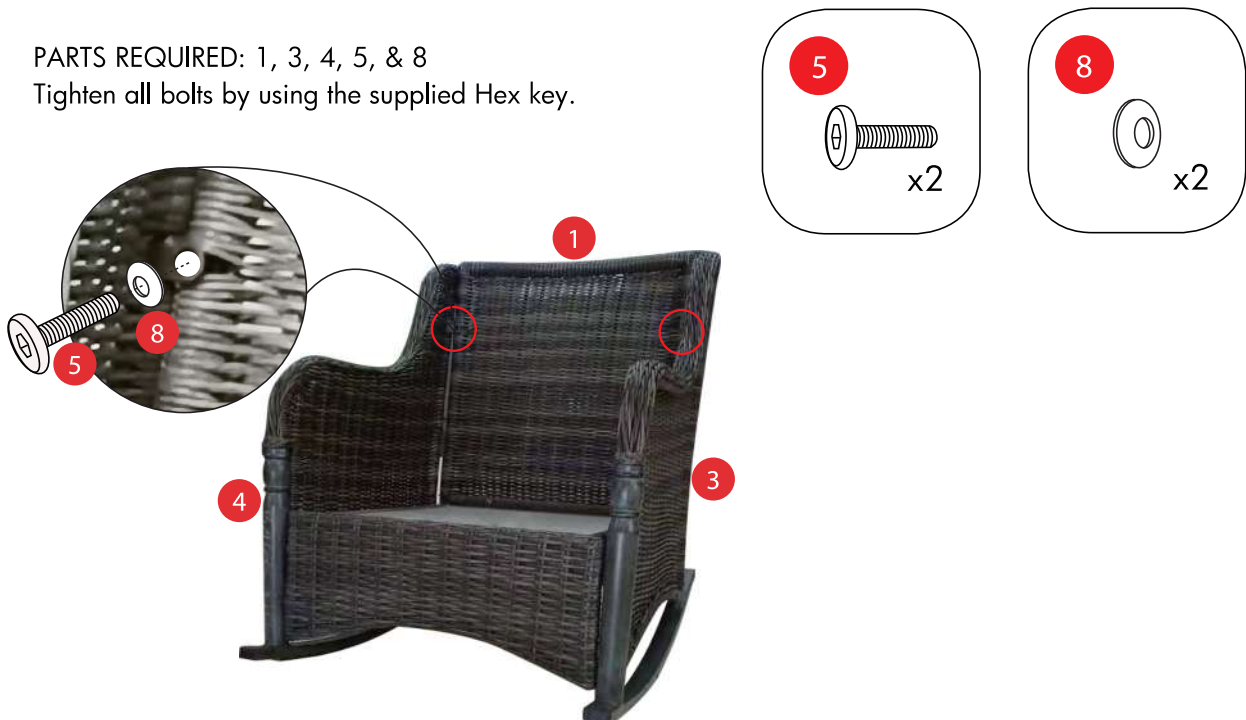

STEP 4



PARTS REQUIRED: 9 & 10



H21GT720MZ

PARTS LIST

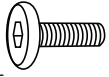
| PART NO. | MATERIAL CODE | PART | Q'TY |
|----------|---------------|--|------|
| 1 | H21GT720MZ-ZM |  TABLE TOP | 1 |
| 2 | H21GT720MZ-JG |  LEG | 4 |

| | | | |
|---|---------------|--|----|
| 3 | H21GT720MZ-ZJ |  SUPPORT | 1 |
| 4 | LS-M6-15 |  BOLT M6*15 | 12 |
| 5 | DP-d6.5-D13 |  WASHER d6.5*D13*1.0 | 12 |

STEP 1

PARTS REQUIRED: 1, 2, 3, 4, & 5
Keep the bolts loose.

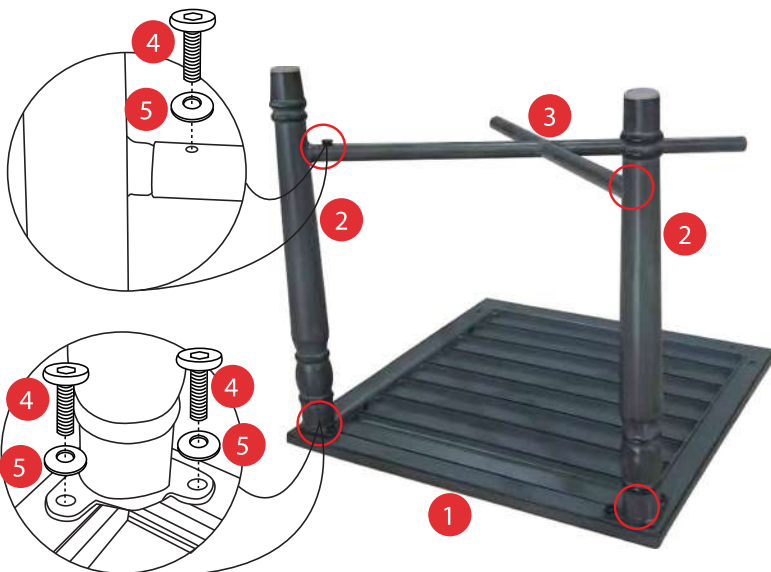
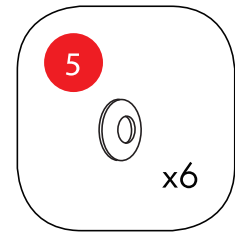
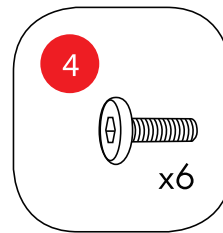

STEP 2

PARTS REQUIRED: 1, 2, 3, 4, & 5

Tighten all bolts by using the supplied Hex key.

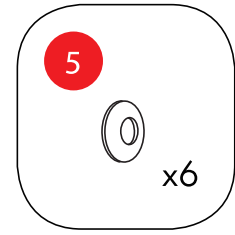
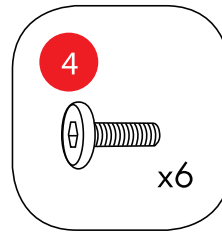
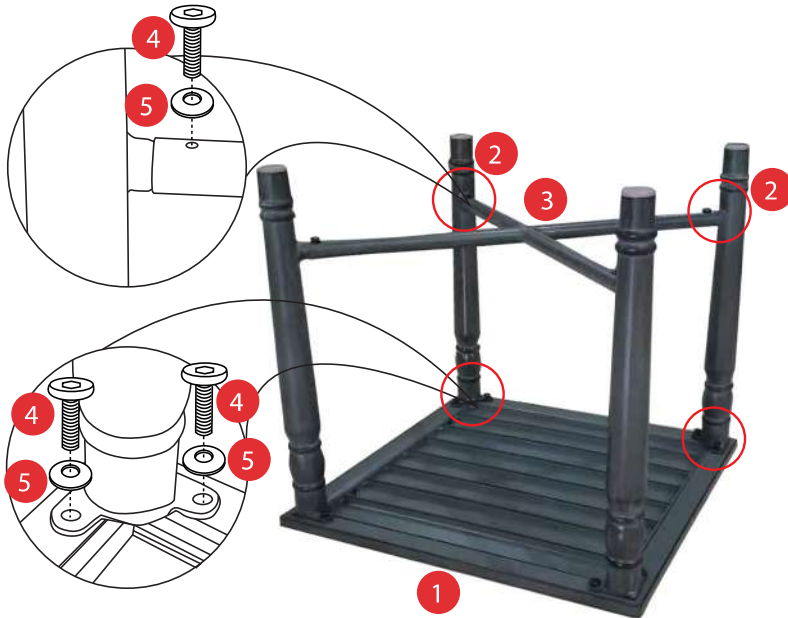

STEP 3



Warranty

- One-year limited warranty.
- Proof of purchase (dated register receipt) is required for warranty claims.
- It remains the customer's responsibility for freight and packing charges to and from the service center.

STOP!

Missing A Part? No Need To Go Back To The Store

The store where you made your purchase does not stock parts for this item.
If you need parts, whether they are missing or damaged,

Call Toll Free:

TEL: 1-877-800-6021

Call us between 9:00 AM and 4:30 PM Eastern Time Monday through Friday
For further assistance, please visit us at service@hcupatio.com