

# 10'X12' Bay Window Gazebo instruction manual

Item #: L-GZ329PST-2

SKU #: 210019491

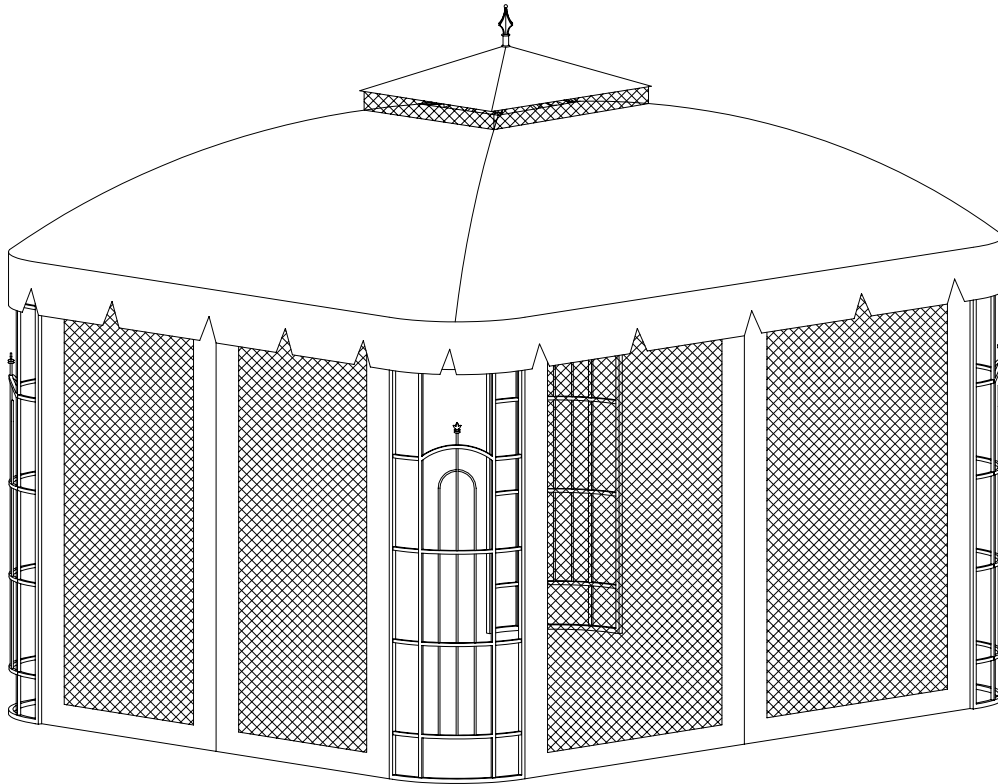









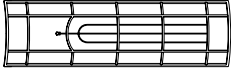



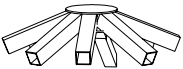
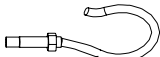
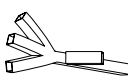

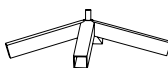

## IMPORTANT:

Please read and follow all safety statements, warnings, assembly instructions, use & care directions before attempting to assemble.





1. When installing and assembling your gazebo, it is recommended that 2 or more adults are involved.
2. Do not use the unit during an electrical storm, as there is a remote chance of getting struck by lightning.
3. Do not climb on top of the gazebo. Falling off the gazebo can result in serious injury, possibly even death.
4. Do not leave the gazebo assembled when there is a risk of high wind, as possible damage will occur to the structure.
5. Never barbecue under this gazebo or use lanterns that contain naked flames.
6. This package contains small items and plastic bags that should be kept away from children.
7. Ensure that all connectors & poles are firmly secured in position fully. It is important to do so before use so as to avoid collapsing or damage to the item, which could result in injury.
8. **WARNING:** Keep all flame and heat sources away from this tent fabric. This tent is made with fabric that meets CPAI – 84 specifications for flame resistance. It is not fire proof. The fabric will burn if left in continuous contact with any flame source. The application of any foreign substance to the tent fabric may render the flame-resistant properties ineffective.
9. **WARNING:** Please take down the gazebo during strong wind. The manufacturer or retailer is not liable for any loss of the product or other items due to the failure to take down the gazebo during strong wind.

**Parts List**

Screen	A	4	
Long Pole 1	B	2	
Long Pole 2	C	2	
Short Pole 1	D	2	
Short Pole 2	E	2	
Big Top Connector	F	1	
Hook	G	1	
Side Pole Connector	H	4	
Long Arc Pole	I	2	
Short Arc Pole	J	2	
Side Pole 1 (Short)	K	4	
Side Pole 2 (Long)	L	4	
Side Pole 3 (Middle)	M	4	
Small Top Connector	N	1	
Small Top Pole	O	4	
Finial	P	1	
Big Canopy	Q	1	
Small Canopy	R	1	
Mosquito Netting	S	1	

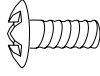
**Tools required: Ladder, Hammer Screwdriver (not included)**

## Hardware Pack 1

AA	M6x15 Bolt	16 PCS	
BB	M6 Washer	16 PCS	
CC	M5 x15 Bolt	20 PCS	
DD	M5 Washer	20 PCS	

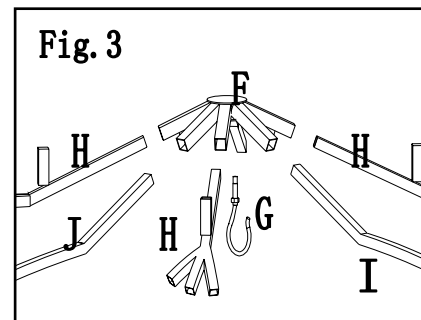
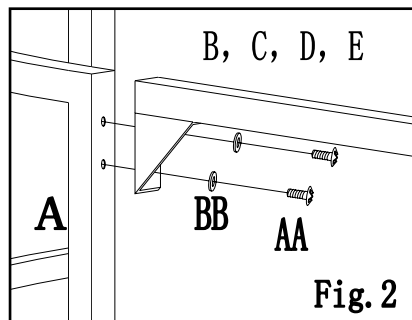
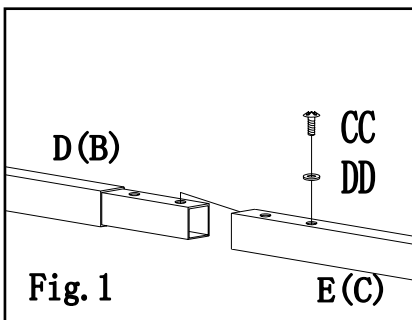
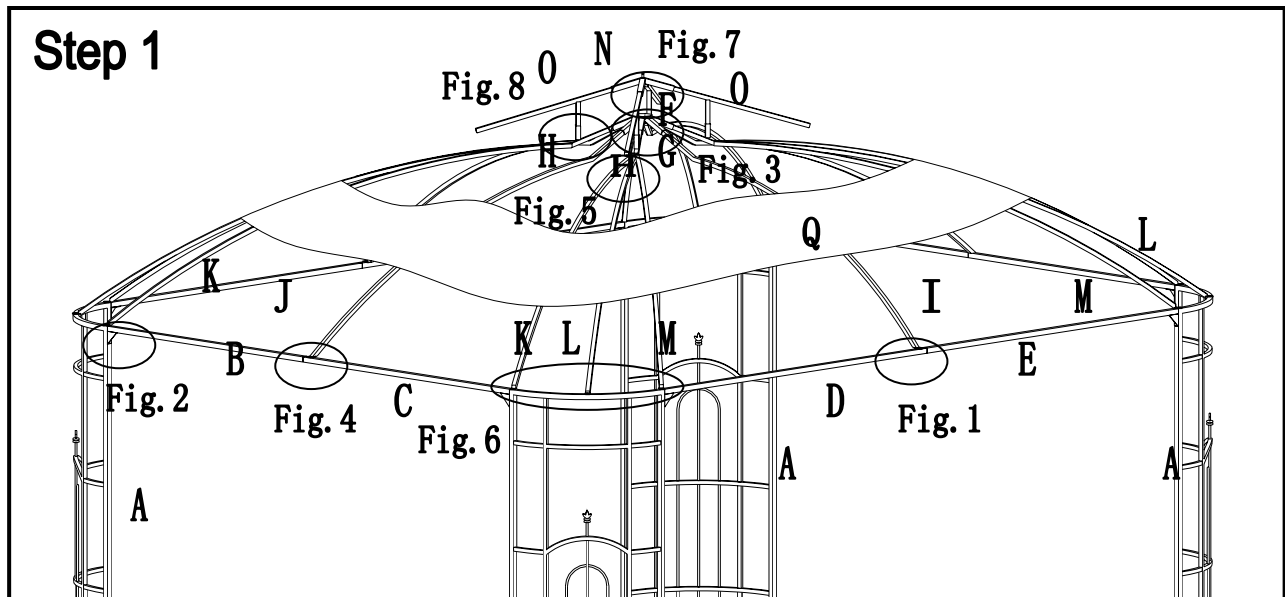

**Fig.1:** Insert Short Pole 1 (D) & Long Pole 1 (B) into Short Pole 2 (E) & Long Pole 2(C), then fully tighten by M5 x15 Bolt (CC) and M5 Washer (DD).

**Fig.2:** Attach the assembled Poles to Screen (A) by M6x15 Bolt (AA) and M6 Washer (BB).

**Fig.3:** Put Hook (G) to Big Top Connector (F), then insert Long Arc Pole (I), Short Arc Pole (J) and Side Pole Connector (H) into Big Top Connector (F).

Please make sure that insert Side pole connector(H) into the longer tube of Big Top Connector (F) .

Insert Long Arc Pole (I) into the shorter tube of Big Top Connector(F) with direct to the shorter side (D and E).

Insert Short Arc Pole (J) into the shorter tube of Big Top Connector (F) with direct to the longer side ( B and C).

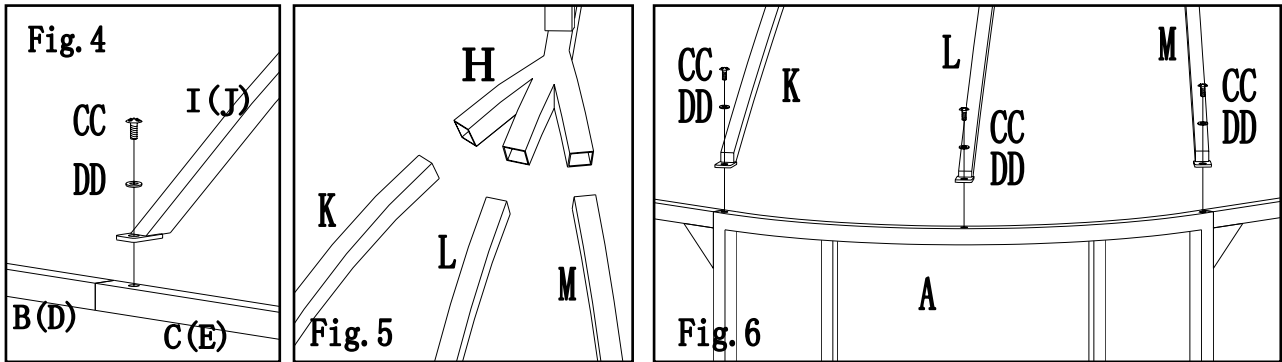

**Fig.4:** Attach Long Arc Pole (I) and Short Arc Pole (J) to the middle of the Poles by M5x15 Bolt (CC) and M5 Washer (DD). Attach Long Arc Pole (I) to Short Pole 1 (D) and Short Pole 2 (E), attach Short Arc Pole (J) to Long Pole 1 (B) and Long Pole 2 (C).

**Fig.5/ Fig.6:** Insert Side Pole 1 (K), Side Pole 2 (L), Side Pole 3 (M) into Side Pole Connector (H), attach the other end to Screen (A) by M5x15 Bolt (CC) and M5 Washer (DD).

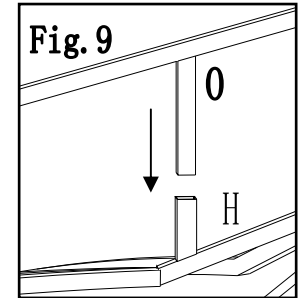
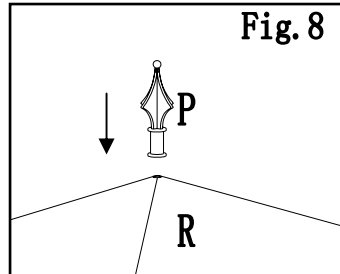
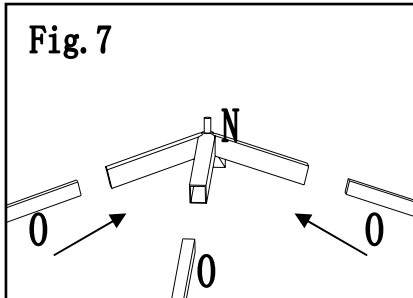
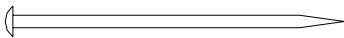
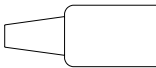

**Fig.7:** Insert Small Top Pole (O) into Small Top Connector (N).

**Fig.8:** Assemble the Small Canopy (R), then put the Finial (P) onto it.

**Fig.9:** Put Big Canopy (Q) onto the Big Top, do not fold, then insert Small Top Pole (O) into Side Pole Connector (H).

## Hardware Pack 2

EE	Plastic Tie	44 PCS	
FF	Φ6x180 Stake	1 2 PCS	
GG	Touch Up Paint	1 PC	

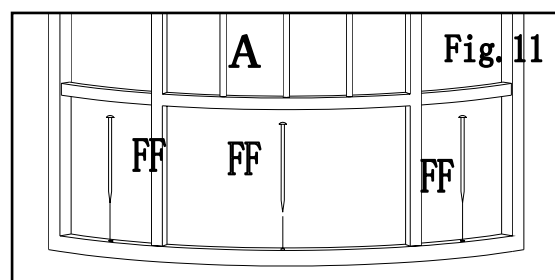
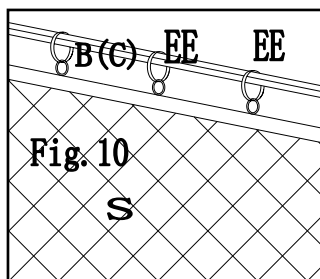
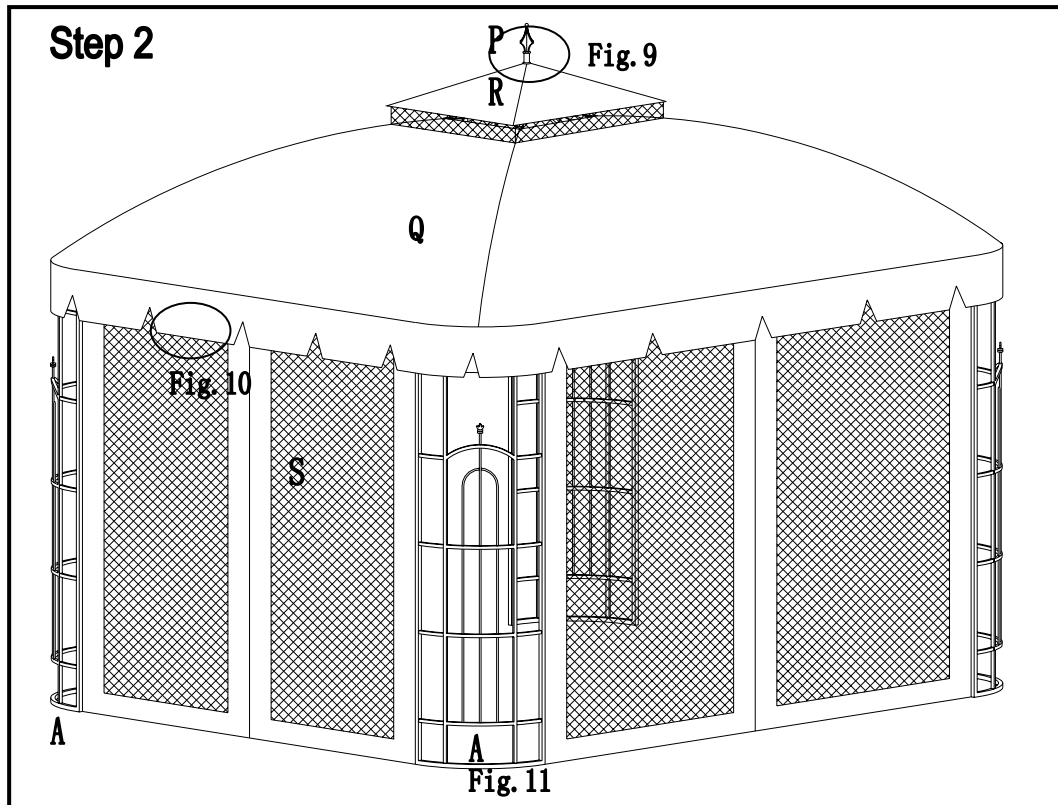

**Fig.10:** Unfolding Big Canopy (Q), then hang up Mosquito Netting (S) to Long Pole 1(B) & Long Pole 2 (C) & Short Pole 1 (D) & Short Pole 2 (E) and Screen (A) by Plastic Tie (EE).

**Fig.11:** Fix the gazebo by Φ6x180 Stake (FF)

**Now your gazebo is ready for use.**

## **USE & CARE**

1. This Gazebo is not a permanent structure and should be disassembled & stored away after use.
2. Do not repack your gazebo until completely dry.
3. This Gazebo must be assembled by two adults or more.
4. This Gazebo must not be left erect in windy conditions.

## **WARNINGS**

1. Assembly Instructions must be followed.
2. Pegs supplied must be used to hold this gazebo in place when upright.
3. Warranty does not cover damage due to extreme weather conditions.

## **CUSTOMER SERVICE**

Sunjoy Industries warrants to the original purchaser that this item is free from defects in workmanship and materials of your item provided the item was factory-sealed at the time of purchase and is maintained with care and used only for personal, residential purposes. The item is warranted to be free from defects in material or workmanship for a period of **6 months**. Should any manufacturing defect arise within this warranty period, Sunjoy Industries will repair or replace (at our option) any defective merchandise upon proof of purchase; however, transportation and delivery costs, as well as labor and material charges to remove or replace parts, remain the responsibility of the purchaser. A purchaser of an "open box," previously-returned, or "clearance" item, as well as original purchasers outside of the warranty period, may obtain replacement parts from Sunjoy Industries for products in current production, at nominal cost.

If you are within the return policy that most stores have, you do have the option of returning this item back to the store which you bought it from for an exchange of the same item, or a refund of the purchase.

If you are within or beyond the return policy that most stores have, and need tech. assistance or replacement parts, please call Sunjoy Industries at 1(866) 578-6569 from 8:30 am to 5:30 pm eastern standard time or e-mail to [Biglots@sunjoygroup.com](mailto:Biglots@sunjoygroup.com) or fax your parts replacement order form together with the purchase receipt to 1 (740) 283-3549 for assistance.